

TS 600

.V8

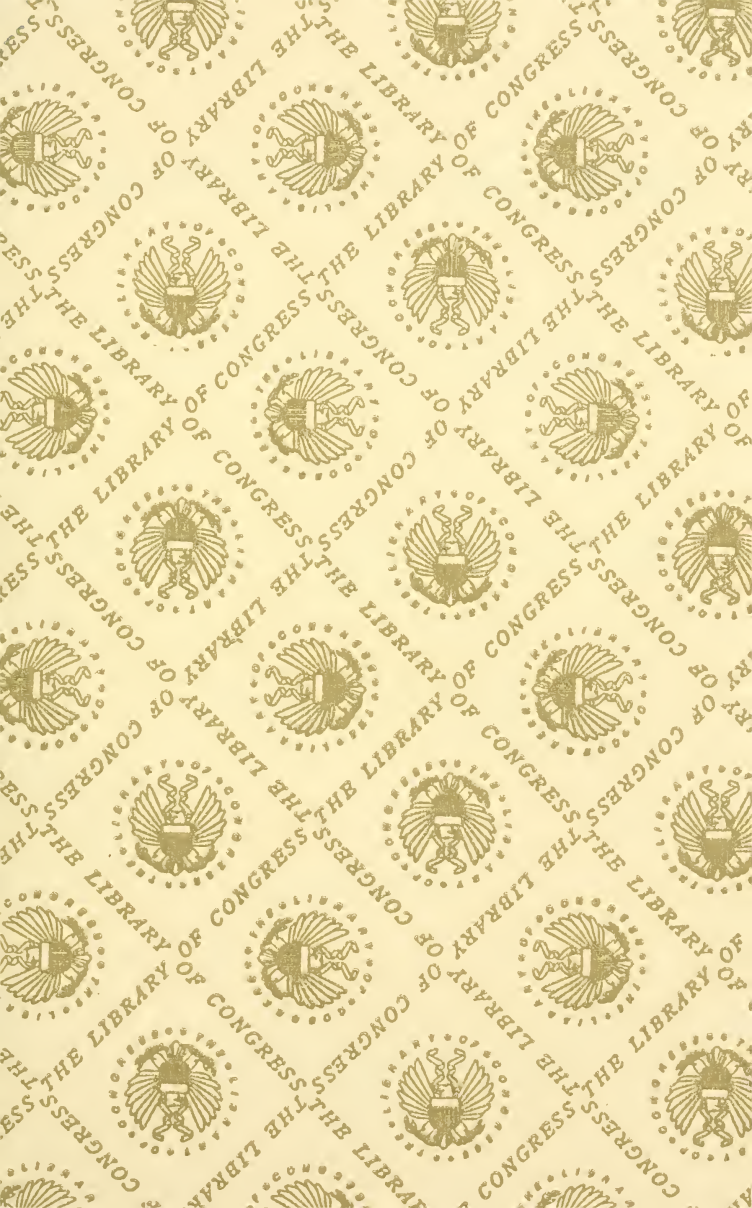



2357
70

THE
TINSMITH'S HELPER
AND
PATTERN BOOK

*WITH USEFUL RULES, DIAGRAMS AND
TABLES*

BY H. K. VOSBURGH

—
REVISED EDITION
—

DAVID WILLIAMS COMPANY

232-238 William St., New York City

1901

TS 600
. V8

THE LIBRARY OF
CONGRESS,
TWO COPIES RECEIVED
MAY. 13 1901
COPYRIGHT ENTRY
APR. 13. 1901.
CLASS. AXXc. No.
7118
COPY B.

COPYRIGHT, 1879
BY H. K. VOSBURGH.

COPYRIGHT, 1901
BY DAVID WILLIAMS CO.

1-31934

[Faint, illegible text]

INTRODUCTORY.

The first edition of this book appeared in 1879, and since then it has had a continual and increasing sale. The author, H. K. Vosburgh, knew from experience the needs of the practical tinner and prepared a book in which a number of simple patterns were described in the plainest way. In preparing the new edition the cuts have been re-engraved and the appendix has been thoroughly revised, bringing the tables up to date and introducing new ones that have undergone changes since the first edition of the book appeared.

INDEX.

	PAGE.
Arc, To find the center of.....	7
Balls, To describe gores for pattern.....	32
Boiler block, Description of.....	66
Boiler, oval, To find length of sheet.....	26
Breasts for cans, To describe.....	10
Can breasts	11, 12
Center of an arc, To find the.....	7
Circle, To describe octagon within.....	9
Cone, Old German rule for patterns.....	18
Cone, Pattern for.....	13
Cover, Oval boiler.....	27
Elbow in five sections.....	58
Elbow, To describe, quick method.....	53
Flaring article, square top, rectangle base, To describe pattern	46
Flaring article, top and base rectangles.....	48
Flaring article with straight sides and round ends, To describe pattern	42
Flaring hexagon article, To describe pattern.....	44
Flaring oval vessel, two pieces, To describe pattern...	40
Flaring square vessel, To describe pattern.....	45
Flaring tinware, To describe patterns for.....	16

Flaring vessels in three pieces.....	20
Flaring vessels, To describe pattern for.....	14
Four-piece elbow, To describe.....	56
Frustum of a cone.....	19, 21
Funnel, Rectangular.....	22
Gores for balls, To describe pattern for.....	32
Heart with square and compass.....	30
Hexagon article, flaring, To describe pattern.....	44
Hood for stove pipes, To cut.....	15
Measure lip	28
Mensuration, Epitome of.....	69
Obtuse elbow, To describe.....	60
Octagon, tapering, To describe.....	47
Octagon within circle, To describe.....	9
Octagon within square, To describe.....	8
Oval boiler cover.....	27
Oval boiler, To find length of sheet.....	26
Oval flaring vessel, four pieces, To describe patterns..	43
Oval, To describe.....	34, 36, 37
Oval, To describe by string, pins and pencil.....	38
Oval with diameters as 5 to 8, To describe.....	35
Pitched cover.....	29
Rectangular base and round top article.....	50
Rectangular funnel.....	22
Right angle elbow, To describe.....	52
Round base and square top article.....	49
Round top and rectangular base article.....	50

Round top and square base article.....	51
Scale tray or scoop.....	24
Scoop or scale tray.....	24
Square base and round top article.....	51
Square, To describe octagon within.....	8
Square top and round base article.....	49
Square vessel, flaring, To describe pattern.....	45
Star, To describe a.....	31
Steamer	29
Strainer pail	23
Stringing patterns, Mode of.....	64
String pattern	65
Tables, rules and recipes.....	89
Tapering elbow, To describe.....	61
Tapering octagon, To describe.....	47
Tea kettle body, To obtain length of piece.....	63
Three-piece elbow, To describe.....	54
Watering pot breasts.....	23

DIAGRAMS AND PATTERNS.

To Find the Center of an Arc.

Fig. 1.

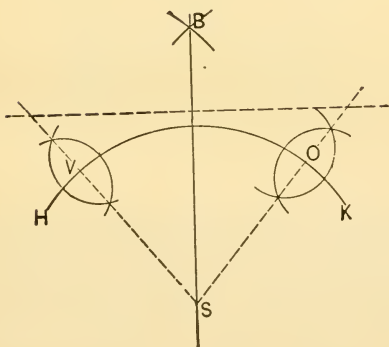

Let H K represent the given arc. Span dividers any convenient radius and describe small arcs, as V O. Draw lines through them, as shown by dotted lines, and the intersection, S, will be center sought.

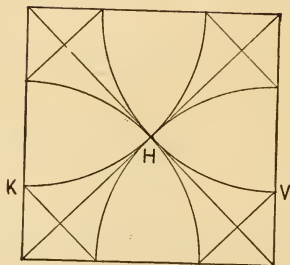
To Describe an Octagon Within a Given Square.*Fig. 2.*

Draw diagonal lines from corner to corner and the intersection is the center H. With the compasses set to a radius from center to corner, and one foot set successively at each corner, describe the arcs, as shown. The points at which they cut the square, as K V, will be the corners of the octagon. Draw lines from point to point to complete the figure.

To Describe an Octagon Within a Given Circle.

Fig. 3.

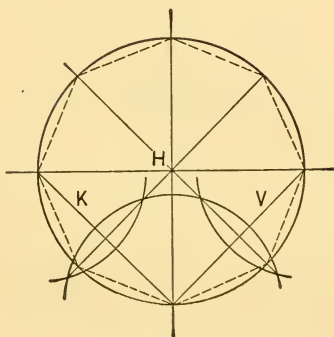

Draw lines at right angles passing through the center H. This divides the circle into four equal parts, which need only to be subdivided into equal parts again to form the corners for the octagon. This may be easily done by drawing the lines K V, bisecting, as shown, and drawing lines to the circle.

The bottom will correspond in size to the size of the circle or square. Remember to allow for burr and double seam.

To Describe Breasts for Cans.

Fig. 4.

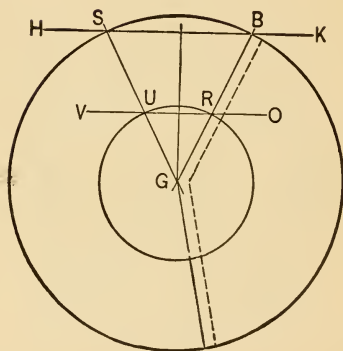

Draw horizontal line H K, another parallel to it, V O, making the distance between the desired height of breast. On H K lay off diameter of can, as S B. On V O, size of opening as U R, produce lines B R, S U, until they cross G. Span dividers from G to S, describe outer circle. G to U, describe inner circle. Set off outer circle equal to the diameter of the can B S. Starting at B, draw line from G, allowing for locks, as shown by dotted lines. *Reference can be made to the circumference table.*

Can Breasts.

Fig. 5.

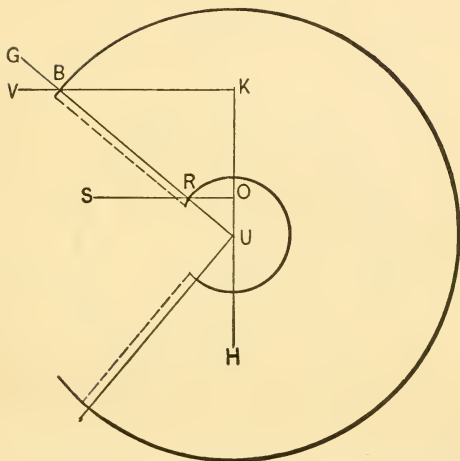

Draw the two horizontal lines, KV and OS , and perpendicular to them the line KH . Set off on line KV from the point B one-half the diameter of the can. On OS the point R is one-half the diameter of the opening. Produce the line UG , touching the points B and R , until it intersects HK . From U as center, with the radius UB , describe the outer circle. With the radius UR , the inner. Then span from K to B and step six times on large circle to obtain size of breast. Draw line to center and allow for locks, as shown by dotted lines.

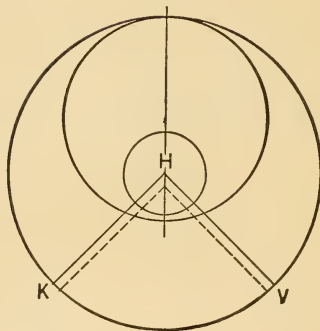
Can Breasts.*Fig. 6.*

Describe circle size of can. Draw line through center H. Span dividers three-fourths of diameter and strike circle K V. Span to diameter of can and step three times on large circle.

Draw line from center to points K V, allowing for edges and locks. For more or less pitch make circle K V larger or smaller.

Small circle in center for opening in top. Hoods and pitched covers may be cut by same rule.

Pattern for Cone.

Fig. 7.

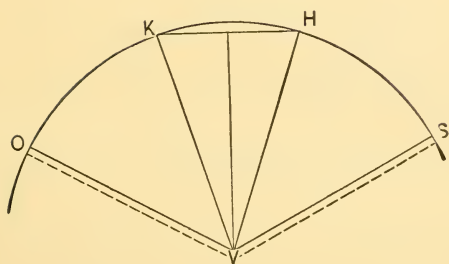

$H K V$ represents a cone for which an envelope is wanted.

Span the dividers from V to H and describe the semi-circle O, S . Set off the circle equal in length to the circumference of the required cone. Draw the lines $V O$ and $V S$, allowing for locks or laps, as shown by the dotted lines.

For the circumference, refer to the tables or obtain by some of the rules. By using the rules familiarity with them is obtained, which is desirable.

To Describe Pattern for Flaring Vessels.

Fig. 8.

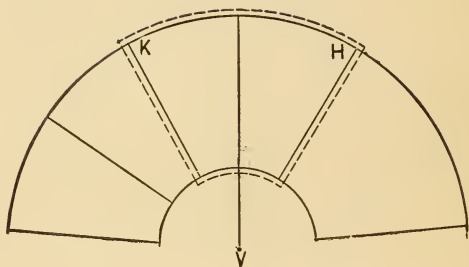

For example, it is desired to describe pattern for pail 12 inches in diameter at top, 9 inches at bottom and 9 deep.

Take the difference between large and small diameters (3 inches) for the first term, the height for the second and the large diameter for the third, thus, 3 : 9 : : 12.

$12 \times 9 \div 3$, this gives radius by which the pattern may be described. Span the dividers (or use beam compasses, piece of wire, straight edge or any convenient device) 36 inches and strike large circle. With radius less the height of pail (9 inches) strike small circle. Ascertain the cir-

cumference required and divide by the number of pieces to be used. Lay off on outer circle and draw lines to center, as H K V.

Allow for locks, burr and wire.

To Cut Hood for Stove Pipes.

Span dividers size of pipe, describe circle, cut in to center, lap over and rivet.

When sold by the pound there will be no waste.

To Describe Patterns for Flaring Tinware

Fig. 9.

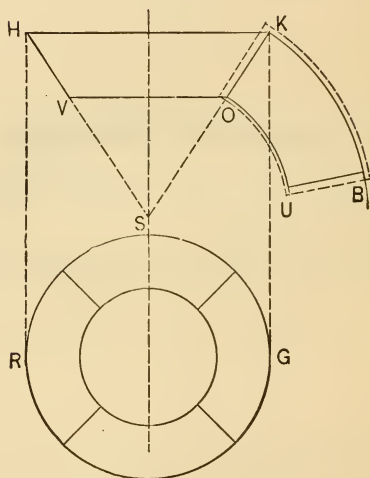

By this figure and rule can be drawn any article of flaring tinware of any diameter, large or small. It is a rule of more extensive application than any other for getting correct patterns for frustums of a cone. It is the foundation for all curved work, cornice, bevels, chamfers, etc.

H K V O represents the elevation of an ordinary tin pan, constructed in four pieces, $15\frac{1}{2}$ inches in diameter at the top. Below the elevation is shown the same in plan; the pan is a frustum of a cone, and if the sides of the pan

were continued down until they intersected at S, as shown, the cone would be complete. The radius of the envelope of the cone must be either S H or S K. To describe the section of the frustum which is required, place one foot of the dividers at the center S, and with the radius S H describe the arc K B. With the radius S V describe O U. This gives the width of pattern and the proper sweep.

To get the length of the piece, refer to the table of circumferences or find, by the rules given, the circumference of the article, which in this case is $48\frac{5}{8}$ inches. There being four pieces, divide by four, which gives 12 $5\text{-}32$ inches; span the dividers 1 inch, step off the 12 and add the fraction.

Draw line from center S to point last ascertained. For locks, wire edge and burr allowance must be made.

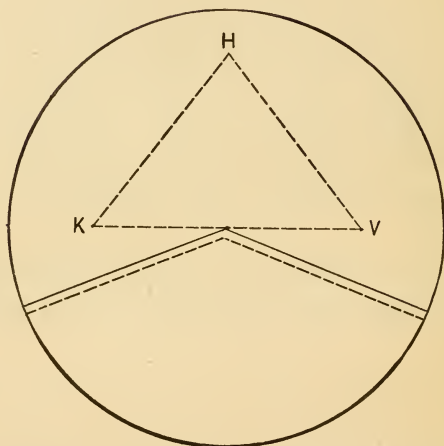
The Old German Rule for Patterns for the Cone.*Fig. 10.*

Take the slant height of the cone $H K$ as a radius, and describe a circle. Divide the diameter of the base of the cone $K V$ into seven equal parts and set off a space equal to twenty-two of these parts on the circle already struck. From the extremities thus measured off draw lines to the center.

Allow for locks.

Frustum of a Cone.

Fig. 11.

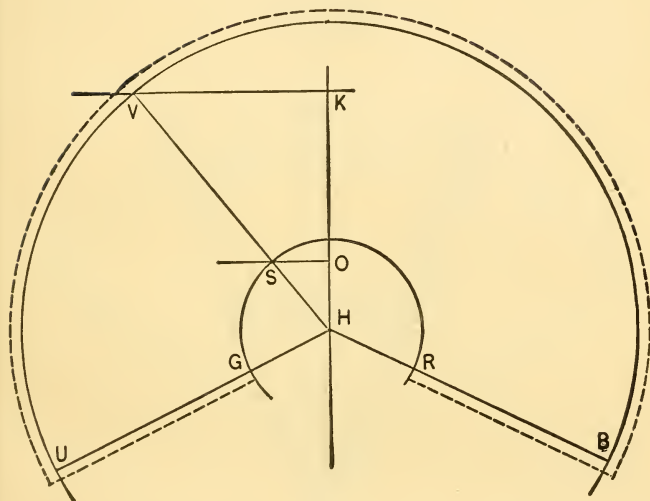

Lay the square on your sheet and construct the right angle $H K V$. Draw line $O S$ parallel to $K V$, making the distance $K O$ the altitude. On these lines lay off one-half the diameter of the large and small ends. Draw line through points V and S until they intersect at H ; then, with H as the center, describe the semicircles $B U$, $R G$. Lay off circumference of large end on line $B U$ and draw lines to center H . Must allow for all edges. For two sections take one-half of the piece, allowing edges on piece used for pattern.

Flaring Vessel in Three Pieces.

Fig. 12.

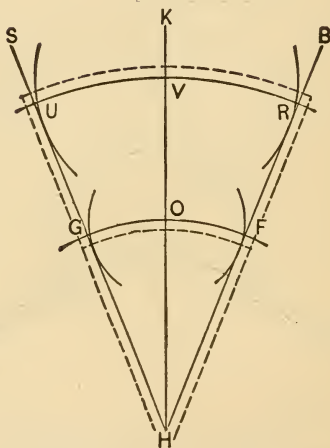

Draw line H K; perpendicular to it, lines parallel to each other apart the height of vessel. With the intersections, as V, O for centers, describe circles size of top and bottom of vessel. Draw lines S H and B H touching on circles, and at intersection H as center, with the radius H V, describe the segment U R; with the radius H O, the segment G F. Allow for locks, as shown by dotted lines.

Frustum of a Cone.

Fig. 13.

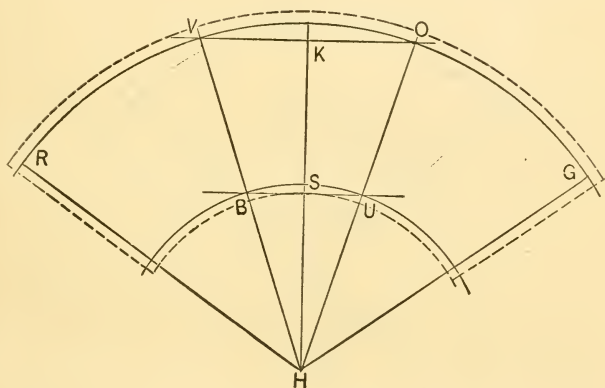

Draw perpendicular line H K, and from K lay off diameter of large end, as V O on the line H K the height of frustum, as K S. Draw line parallel to V O, and on it lay off small diameter, as B U. Draw lines through points V B and O U until they intersect at H. Span compasses from H to V and draw large arc R G; from H to B and describe small arc. Allow for all edges, wire, burr and locks. This forms a pattern in one piece.

Rectangular Funnel.

Fig. 14.

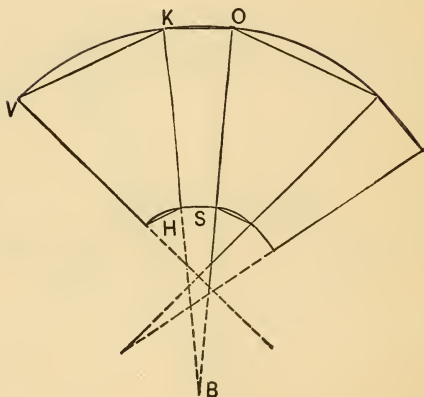

Draw side elevation, as $H K V$. Continue side lines as shown by dots. From point of intersection as center, describe arc and chord $K V$ and H . Draw end elevation $O K S$, lines produced to intersect at B . From B as center describe arc and chord $O K$ and S . The other side and end obtained in the same manner, as shown in cut. Can be made in two or more pieces by dividing. All locks and edges must be allowed for on the pattern piece.

For Strainer Pail or Watering Pot Breast.

Fig. 15.

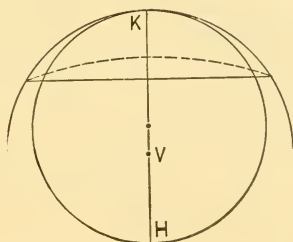

Strike circle size of pail or pot. Span dividers $1\frac{3}{4}$ inches, more or less, being governed by pitch desired, as from V to K, and describe the arc. Draw the chord, making the segment which is the pattern the desired width. The breast may be cut out if preferred, as shown by dotted lines.

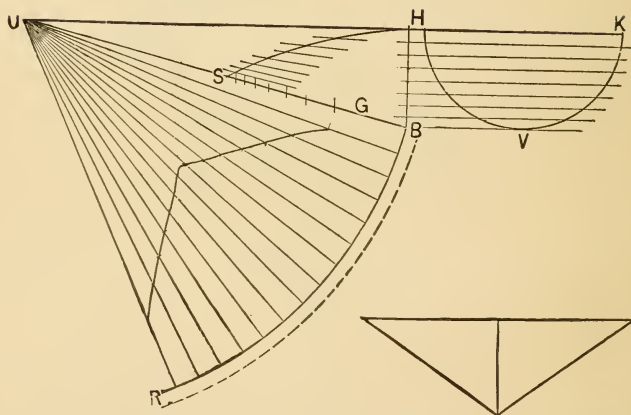
Scale Tray or Scoop.*Fig. 16.*

Construct a sectional view of the scoop, as *H K V*; it being made in two pieces, let *H S B* represent one-half elevation of it. Continue the lines *B S* and *H K* until they cross at *U*. Divide *H K V* into any given number of spaces, continuing the same to the line *H B*, as shown by short lines. Then from the point *U* to the division points on the line *H B*, with rule crossing the line *S H*, mark

the intersections on the line S H. With the T square at right angles with H U, drop the points thus obtained on H S onto the line B S.

With U as center and U B as a radius describe the arc B R. Step off upon it spaces equal to the length H K V, with dividers set the same, which gives the length B R. Draw radial lines from U to space marks on line B R, as shown.

Span the dividers from U to G on the line U B and carry the distance to the first radial line; do likewise with all those spaces on the line. Then a line traced through the points thus obtained, together with the arc B R, will be the outline of the required pattern. Allow for edges, as shown by dotted lines.

To Find Length of Sheet Required for Oval Boiler. Common Method.

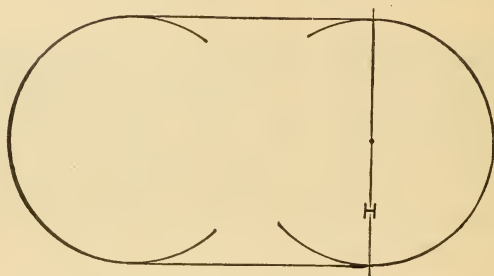
Fig. 17.

Describe bottom, length and width desired, and from H as a starting point roll on the bench to obtain circumference. If three pieces are to be used, cut the circumference of the bottom, edges being allowed; if but two, $\frac{3}{8}$ inch smaller; if but one, $\frac{3}{4}$ inch smaller; if more than three pieces, add $\frac{3}{8}$ inch for every extra piece; or, to twice the length of the bottom add the width and allow $\frac{1}{2}$ inch for every lock or seam. Cut the cover the same size as bottom, by figure.

Or, burr, bottom and roll as above. Use strip $1\frac{1}{4}$ inches less in length after locks are all turned.

Oval Boiler Cover.

Fig. 18.

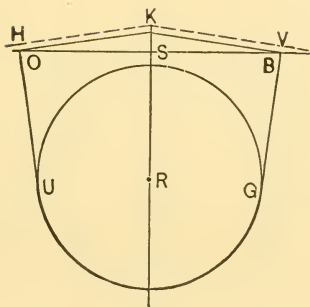

Draw line R K, and from R as center describe circle G U, size of the boiler outside of rod. On the line R K erect line H V. From center R to S, one-half entire length of boiler; from S to K, $\frac{3}{8}$ inch or more if more pitch is desired. Lay corner of square on line at H, one blade at K, the other touching circle, describe lines U H K; corner at V, G V K. Allow for locks and notch for edges.

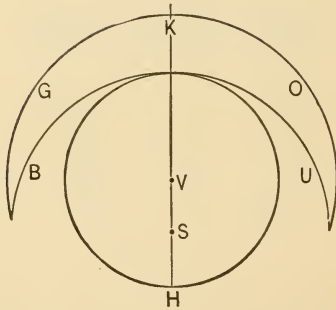
Measure Lip.*Fig. 19.*

Draw line H K and upon it, with V as center, describe circle size of measure. With S as center, half distance from V to H, describe semicircle B U. With V as center describe G O the desired width. Cut on B U and G O to obtain the lip.

Steamer or Pitched Cover.*Fig. 20.*

Strike circle one inch larger than rim burred. Draw line through center H, and from either side 1 inch on circle to 1 inch from center K. Draw lines and cut out. Or, strike circle the same or larger. Draw line through center and cut on it to center. After burring put in rim; draw up and mark, cutting out triangular piece and soldering. Much quicker and equally as good.

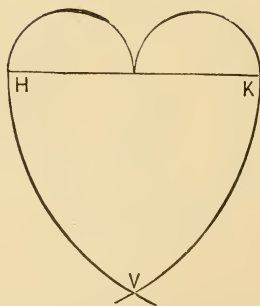
Heart with Square and Compass.*Fig. 21.*

Draw line H K and on it two semicircles. Span dividers from H to K and make sweep to V. Let H to K represent the breadth of the heart.

To Describe a Star.

Fig. 22.

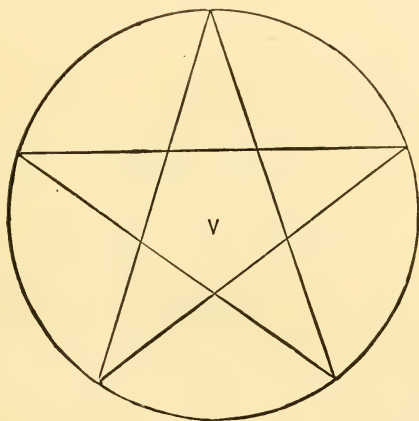

From V as center strike circle size of star desired. Open dividers to one-fifth of circumference, make five steps on circle and draw lines to points.

There is a rule for finding the points of a star other than stepping, but I do not give it. I have found the mode given to be the quickest and most accurate.

Pattern for Cutting Balls.—To Describe the Gores.

Fig. 23.

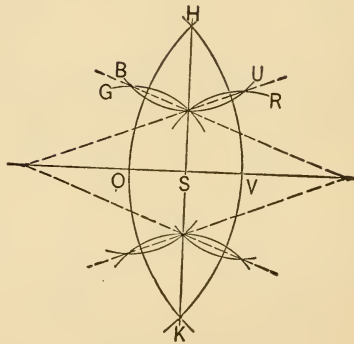

Erect perpendicular line $H K$ equal to one-half the circumference of the ball; divide this line into one-half as many equal parts required; make the line $V O$ equal to one of these pieces, cutting $H K$ through the center at right angles; then with H and K as centers, with radius greater than one-half the distance $K S$, describe the two arcs $B U$; with V and O as centers, arcs $R G$; draw lines

through these points, as shown by dotted lines. From points of intersection describe arcs H V K and H O K, and you obtain pattern for one piece. Allow for laps or seams. The more pieces used the better globe produced. Good results obtained by slightly raising the pieces.

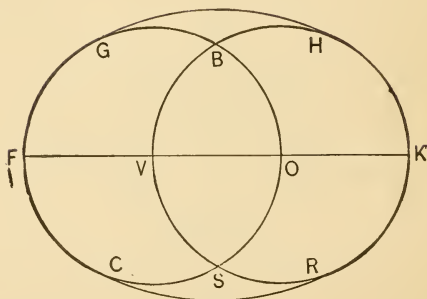
To Describe an Oval.*Fig. 24.*

Draw horizontal line $F K$, span the dividers one-third the required major diameter, and from V and O as centers describe circles, as shown; then span dividers two-thirds entire length, and, with one foot at the intersection of the circles, as S and B , draw the arcs $G H$ and $U R$, which completes the oval.

The proportion of the diameters is about as 3 to 4.

To Describe Oval with Diameters as 5 to 8.

Fig. 25.

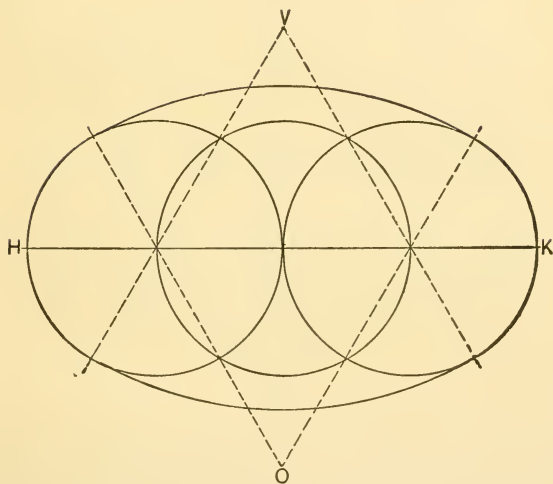

Draw horizontal line $H K$. Span compasses one-quarter the long diameter and describe three circles with that radius, as shown by diagram. Then draw lines through centers of outer circles and their intersections, as shown. The oval is completed by drawing the arcs connecting the outer circles from points V and O as centers.

To Describe an Oval. Another Method.

Fig. 26.

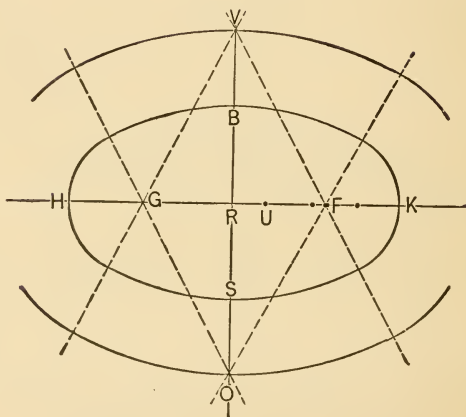

Draw horizontal line $H K$ and perpendicular to it $V O$. Let $H K$ equal the long or transverse diameter, and $S B$ the short or conjugate. Lay off the distance $S B$ on the line $H K$, as from H to U . Divide the distance $U K$ into three equal parts. From R , the center, set off two of the parts each side, as $G F$. On the line $V O$ set off the distance $G F$ from R , as $R V$ and $R O$. From V and O draw lines passing through G and F , as shown. From the points V , O , G , F as centers describe the arcs that complete the ellipse.

To Describe an Oval. Another Method.

Fig. 27.

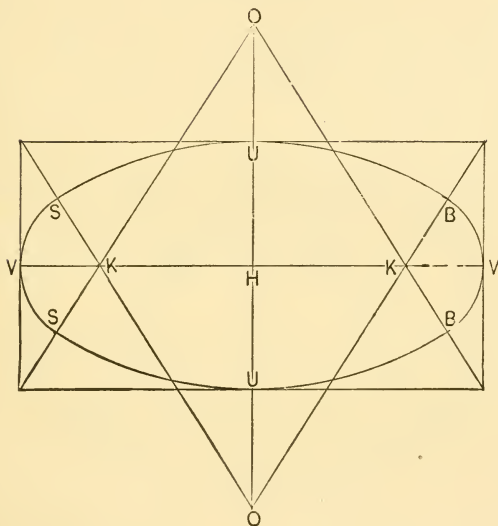

Construct the parallelogram equal in length and width to the long and short diameters of the oval desired. Divide it into four equal parts by drawing lines through the center, crossing at H. Mark the points K and K one-third the distance from V to H, and draw lines from the corners through these points until they intersect, as shown at O. Then from O and O as centers describe the arcs S U B and S U B; from K and K as centers the segments B V B and S V S.

To Describe Oval by Means of String, Pins and Pencil.

Fig. 28.

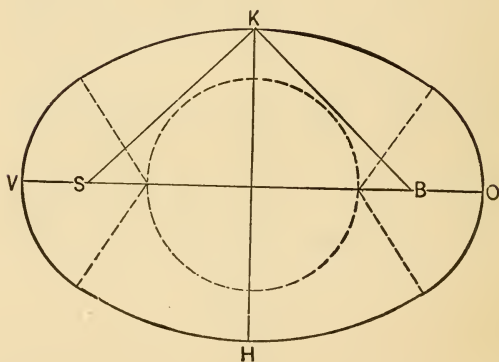

Erect perpendicular line $H K$ equal to short diameter and at right angles to it $V O$. Span dividers one-half the length of the oval, and with H and K as centers describe the arcs S and B . Set pins at these points, and, with a string (one that will not stretch) tied around them so that the loop when drawn tight will reach H or K , as shown, draw the figure with pencil, keeping string equally tense while going around. Of all the apparatus invented

for oval drawing I think the string is the best. The best results, at least, are obtained. To attempt to draw a perfect oval or ellipse by the use of compasses is vain. It cannot be done so that the line will be true, or the proportion or shape satisfactory to one with an eye for correctness or uniformity. The so-called trammels are the next best thing, but no better. A few rules for drawing ovals by the use of dividers have been given in this work so the mechanic may take his choice, and after a little practice with the string and nails will find them the best trammels yet invented for the purpose.

height, as $V O$, describe arc $O U$. Set off the distance $H K$ to B and draw line from this point to center. Lay off the horizontal lines one-half the circumference of the arc $S V S$, Fig. 27, for top and bottom, as $R K, G S$. Draw lines through these points to intersect with perpendicular line at A . Take radius $A G$ on the lines $K V$ and $H V$, as $D O$ and $C U$, and describe the arcs $O E$ and $U F$; also, from same center, the top arcs. Set off on the arcs $U F$ and $O E$ the distance $V S$, Fig. 27. Draw lines through these points to centers C and D . Allow for all edges, locks, wire and burr.

To Describe Pattern for Oval Flaring Vessel.
Four Pieces.

Fig. 31.

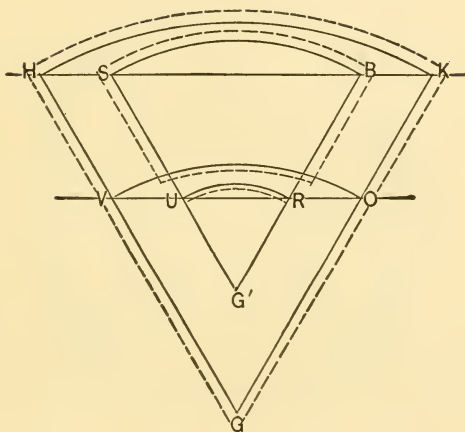

Describe bottom as by Figs. 27 or 28. Obtain length of arcs S U B and S V S, also length of corresponding arcs at the top and bottom of vessel. Draw horizontal lines H K and V O, making the distance between the desired height. Make H K equal in length to that of the piece at the top, and V O to that of the bottom, for the sides. S B and U R for the end pieces. Produce lines through these points to intersect at G and G'. Describe the arcs from these points. Allow for all edges, locks, wire and burr.

To Describe Pattern for Flaring Hexagon Article.

Fig. 32.

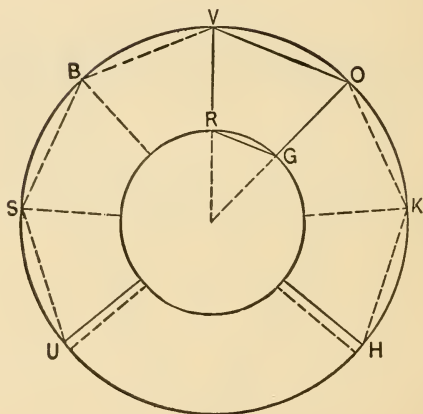

Draw side elevation, as $V O R G$, producing side lines until they cross in the center, as shown by dotted lines. Span dividers from center to O , and describe circle $H O U$; span to G and describe inner circle; span again from V to O and step on the outer circle three spaces each side from O , as V, K, H, S, B, U . Draw lines from these points tending toward center, and connect by chords, as $H K, K B$, etc. Cut out piece $H U$, allowing for locks, as shown. Pattern for a pentagon article may be described by the same rule.

To Describe Pattern for Flaring Square Vessel.

Fig. 33.

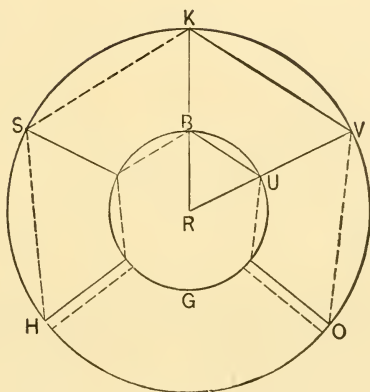

Draw side elevation, as KV , BU , side lines continued until they intersect at R . Make KB the slant height. With radius RK , strike circle UBG . Span dividers from K to V and set off on outer circle the distance, as VO , HS , etc.; draw lines through these points tending toward the center R , also the chords, as shown by dotted lines. Allow for edges. Can be made in two pieces by dividing and allowing for extra lock or seam.

To Describe Pattern for Flaring Article with Square Top and Base a Rectangle. Two Pieces.

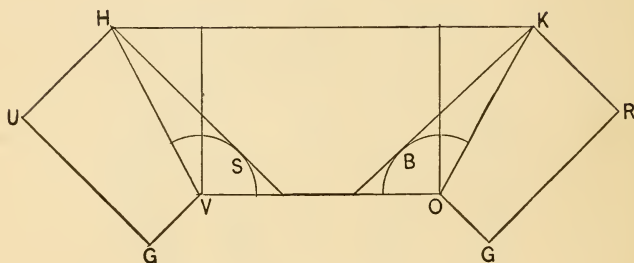
Fig. 34.

Draw horizontal lines H K and V O, making the distance between the slant height. Set off on H K the length of the longest side, and on V O the length of one side of the top. Draw lines through these points, as H V, K O. With a radius equal to one-half of the difference between the shortest side of the base and one side of the top, describes the arcs S and B. With the blade of the square resting on the arc and the corner at H, draw the right angle U H S; the other side the same. Set off the lines U H and K V, equal in length to one-half the short sides, and draw lines at right angles to U H and K V; also lines G V, G O at right angles to U G and R G. Allow for locks and edges,

To Describe Tapering Octagon.

Fig. 35.

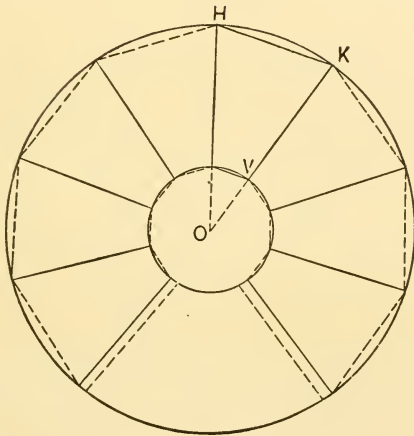

Draw plan of one side, as H K V, and continue side lines until they intersect at O. With O as a center and the radii O V and O H, describe inner and outer circles. Set off on them distances equal to sides of base and top, and connect by chords, as shown by dotted lines. Allow for blocks and edges.

Flaring Article, Top and Base a Rectangle. Two Pieces.

Fig. 36.

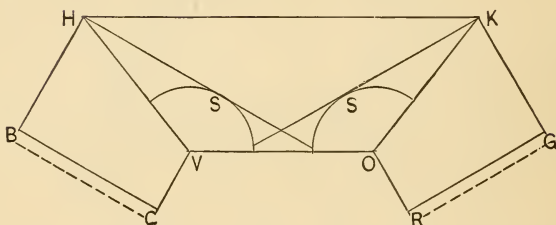

Draw side elevation, as $H K$, $V O$, of the longest side. Span dividers the difference between the shortest side of the base and longest side of top. From V and O as centers describe arcs S and S . With blade of square resting on arcs and the corner at H and K , draw lines $H B$ and $K G$. Set off $H B$ and $K G$ equal one-half of shortest sides of base and draw lines $B U$ and $G R$ at right angles to $H B$ and $K G$; also lines $U V$ and $R O$ at right angles to $U B$ and $G R$. Allow for locks, as shown by dotted lines.

Round Base and Square Top Article. Two Pieces.

Fig. 37.

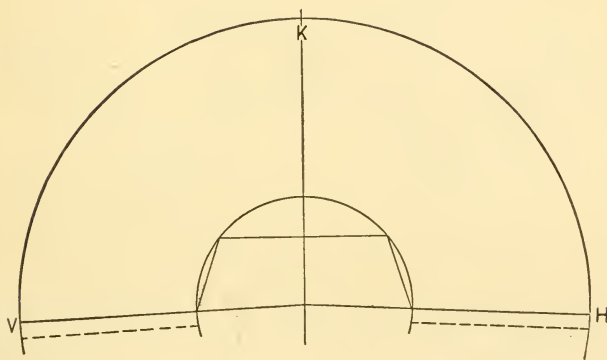

Erect perpendicular line. Span dividers to three-quarters diameter of base and describe semicircle H K V. Set off equal to one-half the diameter of base H K and draw lines to center. Span dividers to one-half size of top, from corner to corner, and describe inner circle. Lay out sides of top, size required, on circle, as shown. Allow for locks.

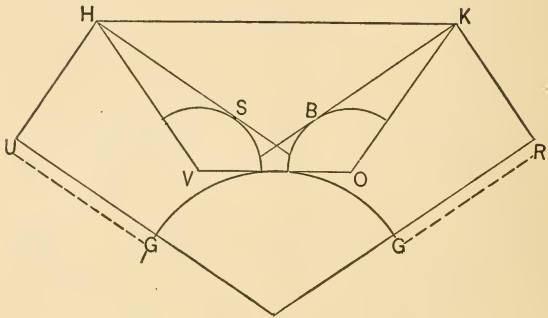
Rectangular Base and Round Top Article.*Fig. 38.*

Draw horizontal lines $H K$, $V O$. Make $H K$ equal to the longest side of base, $V O$ equal to one-fourth the circumference of the top, the distance between slant height; draw side lines through these points, which gives side elevation. With radii one-half the difference between $V O$ and the shortest side of the base, describe the arcs S , B ; with blade of square resting on arcs, and corner at H and K , draw lines $K R$, $H U$; at right angles to $K R$, $H U$, draw lines $R G$ and $U G$; $U G$ and $R G$ produced to intersect; from this point span dividers to line $V O$ and describe the arc. Allow for locks and edges.

Square Base and Round Top Article. Two Pieces.

Fig. 39.

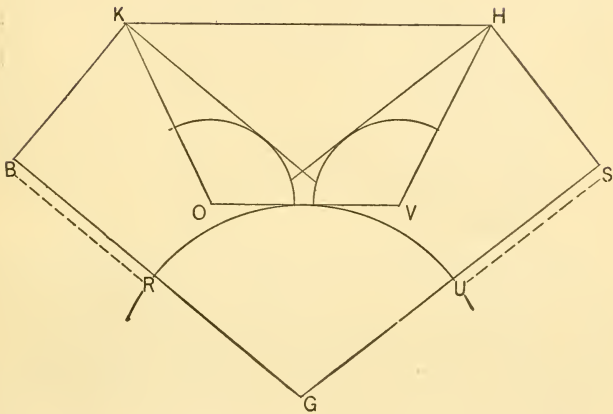

Draw horizontal lines H K, V O; H K equal to the length of one side of the base, V O equal to one-fourth the circumference of the top, the distance between the slant height; draw lines through these points, which gives side elevation; with radii one-half the difference of the two ends, describe arcs; with blade of square resting on arcs and the corner at H and K, draw lines H S and K B; at right angles to H S and K B, S U and B R, produced to intersect at G. Span dividers from G to line V O and describe the arc. Allow for locks and edges.

To Describe a Square or Right Angle Elbow. Two Pieces.

Fig. 40.

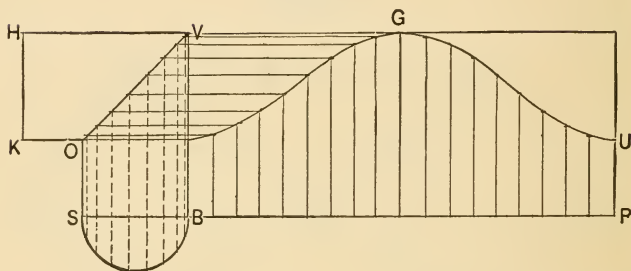

Draw the elevation of the elbow, as B S, O V, K H. Draw line from V to O. Divide one-half of the plan into a convenient number of equal parts, as shown by dotted lines; draw lines at right angles to these, starting, as shown, at the miter line. Make the line R U equal in length to the circumference of the elbow, and draw, directly opposite, the outer end of the elbow. Set off on this line spaces corresponding to those in the plan, the same number each side of the center line; then draw lines parallel to the other arm of the elbow, cutting the corresponding lines as indicated. By tracing through these points the irregular line U G the pattern is obtained. Allow for locks or rivets.

The general principle for cutting elbow patterns is the same throughout, and to understand the principle is to be able to describe pattern for any elbow, at any angle and of any number of pieces. It is the design of this work to make the principle clear.

Quick Method.

Fig. 41.

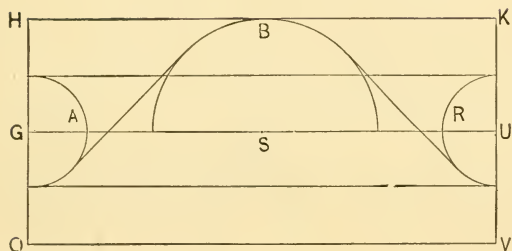

Lay out on sheet length and width required for elbow, as H K, O V; divide into four equal parts, as shown. Span dividers size of pipe and from S as center describe the arc B. From U and G, with one-half radius, describe the arcs A, R. Draw lines to connect, as shown. A very quick way to get a pattern, but will need some trimming. Allow for locks.

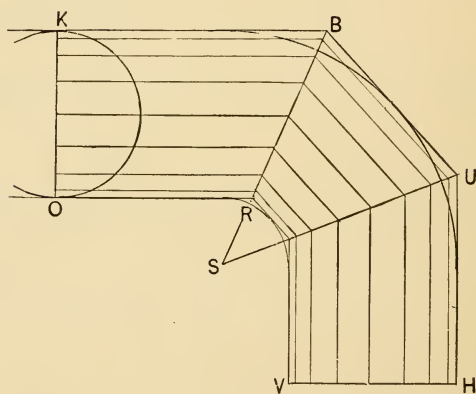
To Describe Three-Piece Elbow.*Fig. 42.*

Lay out two curved lines, H K and V O, corresponding to the desired length of the elbow, making the distance between the diameter. Lay off the circles into three divisions by drawing the lines S B and S U. Describe O K and divide into any convenient number of parts, as shown by figure.

Fig. 43.

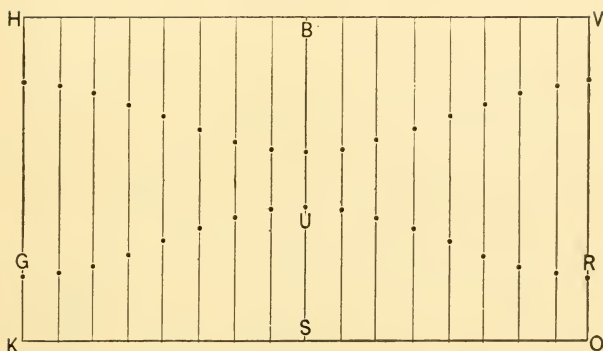

Construct the parallelogram H V K O, equal in length to the circumference of the elbow. Draw through the center the perpendicular line S B, and set off each side of the same spaces corresponding to those in the semicircle O K, making each line of the same length, as K U, O R, etc. A line traced through these points will give pattern for that piece. To obtain pattern for middle piece, it will be necessary to get the length of the lines only; set off each side of B S as before and trace line through the points; so also the third piece. Allow for locks or rivets.

To Describe a Right Angle Elbow. Four Pieces.

Fig. 44.

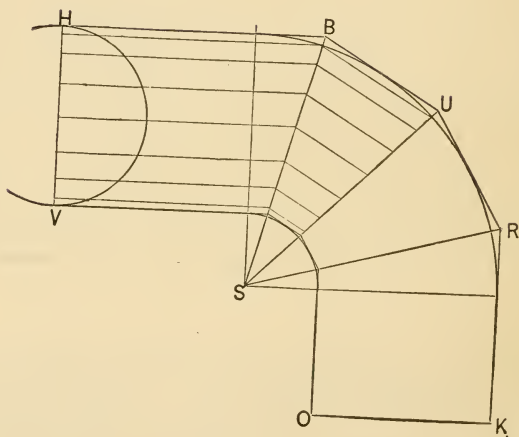

Describe the two curved lines $H K$ and $V O$ corresponding to the desired length of the elbow, making the distance between the diameter of the pipe. Make four divisions by the lines $S B$, $S U$, $S R$. Describe the semi-circle and divide into any convenient number of spaces, as shown by the figure.

Fig. 45.

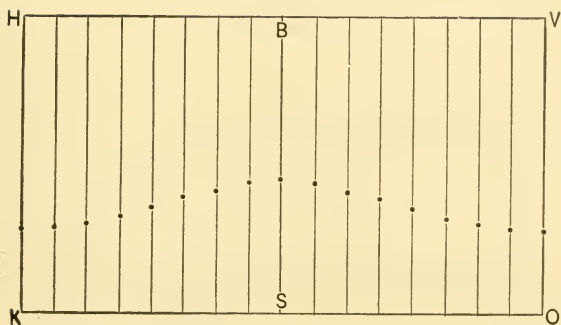

Construct the parallelogram H V K O, equal in length to the circumference of the elbow. Draw through the center the perpendicular line S B, and set off each side of it lines corresponding in length to those in the semicircle O K, as described on page 55. To obtain pattern for the other pieces, proceed as there described. Allow for locks.

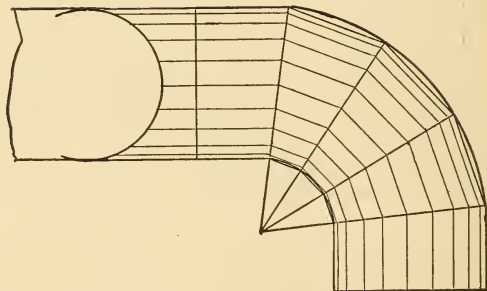
Elbow in Five Sections.*Fig. 46.*

To obtain pattern for elbows of any angle and any number of pieces, it is only necessary to draw a plan of the elbow corresponding in size, number of sections and the desired angle, divide it into any convenient number of equal spaces and proceed as shown on the following page.

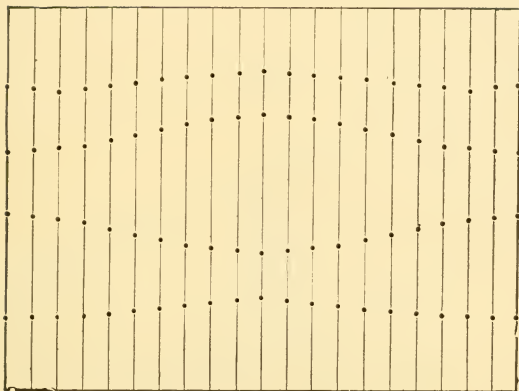
Fig. 47.

Construct the parallelogram and draw lines each side of center corresponding to the number of equal parts the semicircle is divided into, and then set off on each of these lines the length of the same line in the plan and trace through these points to obtain the desired pattern. Every piece must be obtained in the same manner or trimming will be necessary. Reversing pieces to obtain pattern for the next is not altogether reliable, yet perhaps near enough for practical purposes, as trimming is generally done.

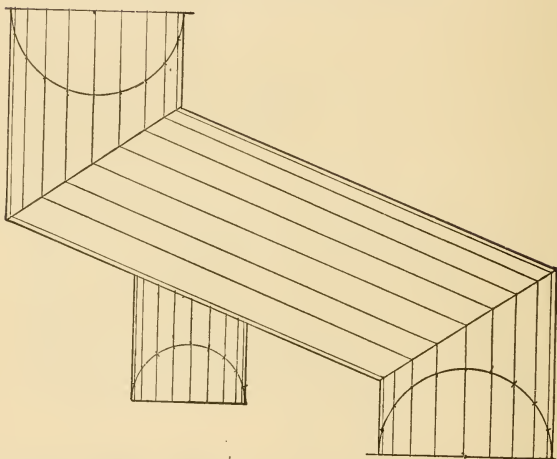
To Describe Pattern for Obtuse Elbow.*Fig. 48.*

It is probably more desirable to fully understand the principle of obtaining elbow patterns at obtuse angles than any other, and when it is understood one can cut pattern for any elbow without difficulty. The principle is the same as has been explained, and, after having drawn a correct representation of elbow, proceed as by rules already given and the result will be satisfactory. T's of all sizes and angles are described in the same manner. First draw an elevation of the desired T, and on the pipe at the desired angle, and it will be plain.

To Describe a Tapering Elbow.

Fig. 49.

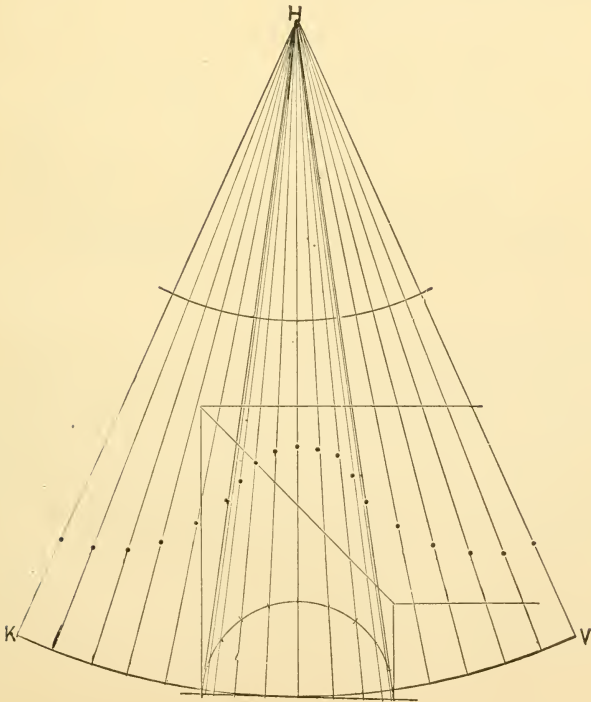

Draw plan of elbow with both ends. Strike first and at any angle desired, drawing miter line, as shown. Then, each side of the center, lay off one-half diameter of small end and produce lines through these points to intersect. With radius from center to ends of elbow, describe the arcs and divide into a number of equal parts and make each correspond with the lines in the plan; a line traced through these points will give the pattern. Allow for locks.

All miter joints obtained in the same manner, whether for elbows, gutters or cornices.

To Obtain Length of Piece for Tea Kettle Body.

Fig. 50.

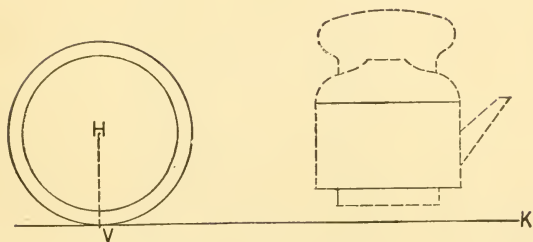

The way in general practice is to roll the bottom after burring on the bench to obtain circumference, and use strip $\frac{3}{4}$ inch less in length, as shown by figure. H represents the pit; K V the length of the strip or sheet. Or, make the body $\frac{5}{8}$ inch less in diameter than the pit or breast, for double seam; for snap or spring bottoms, $\frac{1}{4}$ inch.

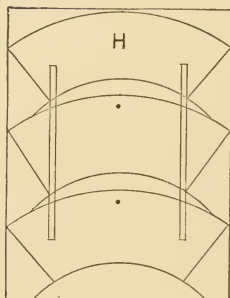
Mode of Stringing Patterns.*Fig. 51.*

This cut represents the three pieces of a 6-quart pan usually cut from one sheet of 10 x 14 tin. Instead of using one piece for pattern and placing it three times, three pieces are fastened together by soldering on two strips of tin with a heavy hem on each side, and all placed at once, thus saving time and vexation. To use to advantage begin at the bottom of the string pattern and mark around on the outside first, and then mark in the centers.

String Pattern.

Fig. 52.

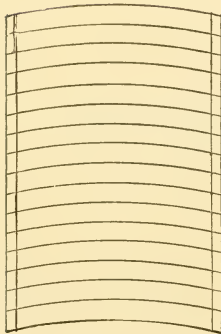

This figure represents a string of rim or hoop patterns, fastened as shown in the same manner as described on page 64. Rims of any width can be put together in this manner and a great saving of time is the result when once properly done. Patterns for all articles of tinware should be strung in this way, when more than one piece is obtained from a sheet, that the marking out may be expedited and less tedious.

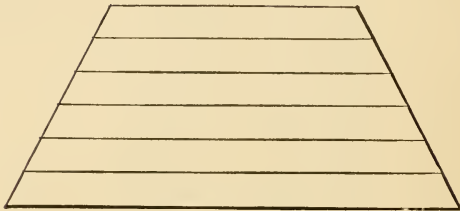
Description of Boiler Block.*Fig. 53.*

By this figure is represented a block for truing up boilers after they are formed up in the rollers and locked together. Many mechanics depend upon the stake and the accuracy of the eye, but after using this method would not abandon it, as better results are obtained and in much less time. The block is made of 2-inch plank, by placing one on another and securing with four long bolts passing through them. The proper dimensions are as follows:

Bottom, 13 inches wide, 25 inches long.

Top, 10 " " 19 " "

Hight, 12 "

APPENDIX.

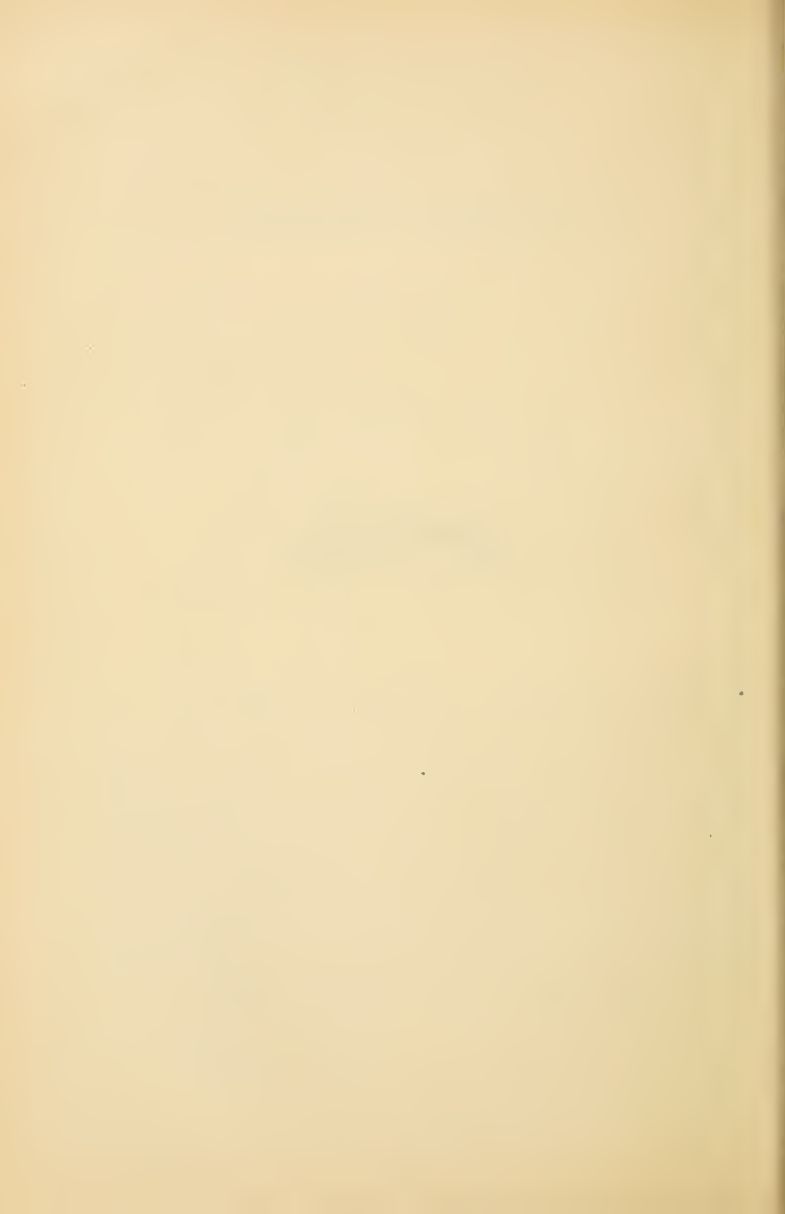

EPITOME OF MENSURATION.

OF THE CIRCLE, CYLINDER, SPHERE, ETC.

1. The circle contains a greater area than any other plane figure bounded by an equal perimeter or outline.

2. The areas of circles are to each other as the squares of their diameters.

3. The diameter of a circle being 1, its circumference equals 3.1416.

4. The diameter of a circle is equal to .31831 of its circumference.

5. The square of the diameter of a circle being 1, its area equals .7854.

6. The square root of the area of a circle multiplied by 1.12837 equals its diameter.

7. The diameter of a circle multiplied by .8862, or the circumference multiplied by .2821, equals the side of a square of equal area.

8. The number of degrees contained in the arc of a circle multiplied by the diameter of the circle and by .008727, the product equals the length of the arc in equal terms of unity.

9. The length of the arc of a sector of a circle multiplied by its radius equals twice the area of the sector.

10. The area of the segment of a circle equals the area of the sector, minus the area of a triangle whose vertex

is the center and whose base equals the chord of the segment.

11. The sum of the diameters of two concentric circles multiplied by their difference and by .7854 equals the area of the ring or space contained between them.

12. The circumference of a cylinder multiplied by its length or height equals its convex surface.

13. The area of the end of a cylinder multiplied by its length equals its solid contents.

14. The area of the internal diameter of a cylinder multiplied by its depth equals its cubical capacity.

15. The square of the diameter of a cylinder multiplied by its length and divided by any other required length, the square root of the quotient equals the diameter of the other cylinder of equal contents or capacity.

16. The square of the diameter of a sphere multiplied by 3.1416 equals its convex surface.

17. The cube of the diameter of a sphere multiplied by .5236 equals its solid contents.

18. The height of any spherical segment or zone, multiplied by the diameter of the sphere of which it is a part and by 3.1416, equals the area or convex surface of the segment; or,

19. The height of the segment multiplied by the circumference of the sphere of which it is a part equals the area.

20. The solidity of any spherical segment is equal to three times the square of the radius of its base, plus the square of its height, multiplied by its height and by .5236.

21. The solidity of a spherical zone equals the sum of the squares of the radii of its two ends and one-third

the square of its hight, multiplied by the hight and by 1.5708.

22. The capacity of a cylinder, 1 foot in diameter and 1 foot in length, equals 5.875 United States gallons.

23. The capacity of a cylinder, 1 inch in diameter and 1 foot in length, equals .0408 United States gallon.

24. The capacity of a cylinder, 1 inch in diameter and 1 inch in length, equals .0034 United States gallon.

25. The capacity of a sphere 1 foot in diameter equals 3.9168 United States gallons.

26. The capacity of a sphere 1 inch in diameter equals .002266 United States gallon; hence,

27. The capacity of any other cylinder in United States gallons is obtained by multiplying the square of its diameter by its length, or the capacity of any other sphere by the cube of its diameter and by the number of United States gallons contained as above in the unity of its measurement.

OF THE SQUARE, RECTANGLE, CUBE, ETC.

1. The side of a square equals the square root of its area.

2. The area of a square equals the square of one of its sides.

3. The diagonal of a square equals the square root of twice the square of its side.

4. The side of a square is equal to the square root of half the square of its diagonal.

5. The side of a square equal to the diagonal of a given square contains double the area of the given square.

6. The area of a recangle equals its length multiplied by its breadth.

7. The length of a rectangle equals the area divided by the breadth; or the breadth equals the area divided by the length.

8. The solidity of a cube equals the area of one of its sides multiplied by the length or breadth of one of its sides.

9. The length of a side of a cube equals the cube root of its solidity.

10. The capacity of a 12-inch tube equals 7.48 United States gallons.

OF TRIANGLES, POLYGONS, ETC.

1. The complement of an angle is its defect from a right angle.

2. The supplement of an angle is its defect from two right angles.

3. The three angles of every triangle are equal to two right angles; hence the oblique angles of a right angled triangle are each other's complements.

4. The sum of the squares of two given sides of a right angled triangle is equal to the square of the hypotenuse.

5. The difference between the squares of the hypotenuse and given side of a right angled triangle is equal to the square of the required side.

6. The area of a triangle equals half the product of the base multiplied by the perpendicular height.

7. The side of any regular polygon multiplied by its apothem or perpendicular, and by the number of its sides, equals twice the area.

OF ELLIPSES, CONES, FRUSTUMS, ETC.

1. The square root of half the sum of the squares of the two diameters of an ellipse multiplied by 3.1416 equals its circumference.

2. The product of the two axes of an ellipse multiplied by .7854 equals its area.

3. The curve surface of a cone is equal to half the product of the circumference of its base multiplied by its slant side, to which, if the area of the base be added, the sum is the whole surface.

4. The solidity of a cone equals one-third the product of its base multiplied by its altitude or height.

5. The square of the diameters of the two ends of the frustum of a cone added to the product of the two diameters, and that sum multiplied by its height and by .2618, equals its solidity.

DEFINITIONS OF ARITHMETICAL SIGNS USED
IN THE FOLLOWING CALCULATIONS.

$=$	Sign of Equality, and signifies as $4 + 6 = 10$.
$+$	“ Addition, “ as $6 + 6 = 12$, the Sum
$-$	“ Subtraction, “ as $6 - 2 = 4$, Remain- der.
\times	“ Multiplication, “ as $8 \times 3 = 24$, Product.
\div	“ Division, “ as $24 \div 3 = 8$,
$\sqrt{\quad}$	“ Square Root, “ Extraction of Square Root.
6^2	“ to be squared, “ thus $8^2 = 64$.
7^3	“ to be cubed, “ thus $3^3 = 27$.

DECIMAL EQUIVALENTS TO FRACTIONAL PARTS OF LINEAL MEASUREMENT.

ONE INCH THE INTEGER OR WHOLE NUMBER.

.96875	equal	$\frac{7}{8}$ and 3-32	.46875	equal	$\frac{3}{8}$ and 3-32
.9375	"	$\frac{7}{8}$ and 1-16	.4375	"	$\frac{3}{8}$ and 1-16
.90625	"	$\frac{7}{8}$ and 1-32	.40625	"	$\frac{3}{8}$ and 1-32
.875	"	$\frac{7}{8}$.375	"	$\frac{3}{8}$
.84375	"	$\frac{3}{4}$ and 3-32	.34375	"	$\frac{1}{4}$ and 3-32
.8125	"	$\frac{3}{4}$ and 1-16	.3125	"	$\frac{1}{4}$ and 1-16
.78125	"	$\frac{3}{4}$ and 1-32	.28125	"	$\frac{1}{4}$ and 1-32
.75	"	$\frac{3}{4}$.25	"	$\frac{1}{4}$
.71875	"	$\frac{5}{8}$ and 3-32	.21875	"	$\frac{1}{8}$ and 3-32
.6875	"	$\frac{5}{8}$ and 1-16	.1875	"	$\frac{1}{8}$ and 1-16
.65625	"	$\frac{5}{8}$ and 1-32	.15625	"	$\frac{1}{8}$ and 1-32
.625	"	$\frac{5}{8}$.125	"	$\frac{1}{8}$
.59375	"	$\frac{1}{2}$ and 3-32	.09375	"	3-32
.5625	"	$\frac{1}{2}$ and 1-16	.0625	"	1-16
.53125	"	$\frac{1}{2}$ and 1-32	.03125	"	1-32
.5	"	$\frac{1}{2}$			

ONE FOOT OR TWELVE INCHES THE INTEGER.

.9166	equal	11 inches.	.1666	equal	2 inches
.8333	"	10 "	.0833	"	1 "
.75	"	9 "	.07291	"	$\frac{7}{8}$ "
.6666	"	8 "	.0625	"	$\frac{3}{4}$ "
.5833	"	7 "	.05208	"	$\frac{5}{8}$ "
.5	"	6 "	.04166	"	$\frac{1}{2}$ "
.4166	"	5 "	.03125	"	$\frac{3}{8}$ "
.3333	"	4 "	.02083	"	$\frac{1}{4}$ "
.25	"	3 "	.01041	"	$\frac{1}{8}$ "

MENSURATION OF SURFACES.

MENSURATION is that branch of Mathematics which is employed in ascertaining the extension, solidities and capacities of bodies capable of being measured.

MENSURATION OF SURFACES.

To Measure or Ascertain the Quantity of Surface in Any Right Lined Figure whose Sides are Parallel to Each Other.

RULE.—Multiply the length by the breadth or perpendicular height, and the product will be the area or superficial contents.

APPLICATION OF THE RULE TO PRACTICAL PURPOSES.

The sides of a square piece of iron are $9\frac{7}{8}$ inches in length, required the area.

Decimal equivalent to the fraction $\frac{7}{8} = .875$, and $9.875 \times 9.875 = 97.5$, etc., square inches, the area.

The length of a roof is 60 feet 4 inches and its width 25 feet 3 inches; required the area of the roof.

4 inches = .333 and 3 inches = .25 (see table of equivalents), hence, $60.333 \times 25.25 = 1523.4$ square feet, the area.

TRIANGLES.

To Find the Area of a Triangle When the Base and Perpendicular are Given.

RULE.—Multiply the base by the perpendicular height and half the product is the area.

The base of the triangle is 3 feet 6 inches in length and the height 1 foot 9 inches; required the area.

6 in. = .5 and 9 in. = .75, hence, $\frac{3.5 \times 1.75}{2} = 3.0625$ square feet, the area.

Any Two Sides of a Right Angled Triangle being Given, to Find the Third.**WHEN THE BASE AND PERPENDICULAR ARE GIVEN TO FIND THE HYPOTHENUSE.**

Add the square of the base to the square of the perpendicular and the square root of the sum will be the hypotenuse.

The base of the triangle is 4 feet and the perpendicular 3 feet; then $4^2 + 3^2 = 25$, $\sqrt{25} = 5$ feet, the hypotenuse.

WHEN THE HYPOTHENUSE AND BASE ARE GIVEN TO FIND THE PERPENDICULAR.

From the square of the hypotenuse subtract the square of the base, and the square root of the remainder will be the perpendicular.

The hypotenuse of the triangle is 5 feet and the base 4 feet; then $5^2 - 4^2 = 9$, and $\sqrt{9} = 3$, the perpendicular.

WHEN THE HYPOTHENUSE AND PERPENDICULAR ARE GIVEN TO FIND THE BASE.

From the square of the hypotenuse subtract the square of the perpendicular, and the square root of the remainder will be the base.

OF POLYGONS.

To Find the Area of a Regular Polygon.

RULE.—*Multiply the length of a side by half the distance from the side to the center, and that product by the number of sides; the last product will be the area of the figure.*

EXAMPLE.—The side of a regular hexagon is 12 inches, and the distance therefrom to the center of the figure is 10 inches; required the area of the hexagon.

$$\frac{10}{2} \times 12 \times 6 = 360 \text{ square inches} = 2\frac{1}{2} \text{ square feet. Ans.}$$

To Find the Area of a Regular Polygon when the Side Only is Given.

RULE.—*Multiply the square of the side by the multiplier opposite to the name of the polygon in the ninth column of the following table, and the product will be the area.*

Table of angles relative to the construction of Regular Polygons with the aid of the sector, and of coefficients to facilitate their construction without it; also, of coefficients

to aid in finding the area of the figure, the side only being given.

Names.	Number of sides.	Angle at center.	Angle at circum.	Perp'n side being 1.	Length of side rad. being 1.	Rad. of cir. side being 1.	Rad. of cir. per. being 1.	Area side being 1.
Triangle	3	120	60	.28868	1.782	.5773	2.	.433012
Square	4	90	90	.5	1.414	.7071	1.414	1.
Pentagon	5	72	108	.6882	1.175	.8506	1.238	1.720477
Hexagon	6	60	120	.866	1.	1.	1.156	2.598076
Heptagon	7	51 3-7	128 4-7	1.0382	.8672	1.152	1.11	3.633912
Octagon	8	45	135	1.2071	.7654	1.3065	1.08	4.828427
Nonagon	9	40	140	1.3737	.684	1.4619	1.06	6.181824
Decagon	10	36	144	1.5388	.618	1.618	1.05	7.694208
Undecagon	11	32 8-11	147 3-11	1.7028	.5634	1.7747	1.04	9.36564
Dodecagon	12	30	150	1.866	.5176	1.9318	1.037	11.196152

NOTE.—“Angle at center” means the angle of radii passing from the center to the circumference or corners of the figure. “Angle at circumference” means the angle which any two adjoining sides make with each other.

THE CIRCLE AND ITS SECTIONS.

OBSERVATIONS AND DEFINITIONS.

1. The circle contains a greater area than any other plane figure bounded by the same perimeter or outline.
2. The areas of circles are to each other as the squares of their diameters; any circle twice the diameter of another contains four times the area of the other.
3. The radius of a circle is a straight line drawn from the center to the circumference.
4. The diameter of a circle is a straight line drawn

through the center and terminating both ways in the circumference.

5. A chord is a straight line joining any two points of the circumference.

6. The versed sine is a straight line joining the chord and the circumference.

7. An arc is any part of the circumference.

8. A semicircle is half the circle cut off by a diameter.

9. A segment is any portion of a circle cut off by a chord.

10. A sector is a part of a circle cut off by two radii.

GENERAL RULES IN RELATION TO THE CIRCLE.

1. Multiply the diameter by 3.1416, the product is the circumference.

2. Multiply the circumference by .31831, the product is the diameter.

3. Multiply the square of the diameter by .7854 and the product is the area.

4. Multiply the square root of the area by 1.12837, the product is the diameter.

5. Multiply the diameter by .8862, the product is the side of a square of equal area.

6. Multiply the side of a square by 1.128, the product is the diameter of a circle of equal area.

APPLICATION OF THE RULES TO PRACTICAL PURPOSES.

1. The diameter of a circle being 5 feet 6 inches, required its circumference.

$$5.5 \times 3.1416 = 17.27880 \text{ feet, the circumference.}$$

2. A straight line or the circumference of a circle being 17.27880 feet, required the circle's diameter corresponding thereto.

$$17.27880 \times .31831 = 5.5000148280 \text{ feet, diameter.}$$

3. The diameter of a circle is $9\frac{3}{8}$ inches; what is its area in square inches?

$9.375^2 = 87.89$, etc., $\times .7854 = 69.029$, etc., inches, the area.

4. What must the diameter of a circle be to contain an area equal to 69.029296875 square inches?

$\sqrt{69.02929}$, etc., $= 8.3091 \times 1.12837 = 9.375$, etc., or $9\frac{3}{8}$ inches, the diameter.

5. The diameter of a circle is $15\frac{1}{2}$ inches; what must each side of a square be to be equal in area to the given circle?

$$15.5 \times .8862 = 13.73$$
, etc., inches, length of side.

6. Each side of a square is 13.736 inches in length; what must the diameter of a circle be to contain an area equal to the given square?

$13.736 \times 1.128 = 15.49$, etc., or $15\frac{1}{2}$ inches, the diameter.

Any Chord and Versed Sine of a Circle being Given, to Find the Diameter.

RULE.—Divide the sum of the squares of the chord and versed sine by the versed sine; the quotient is the diameter of corresponding circle.

7. The chord of a circle equals 8 feet and the versed sine equals $1\frac{1}{2}$; required the circle's diameter.

$$8^2 + 1.5^2 = 66.25 \div 1.5 = 44.16 \text{ feet, the diameter.}$$

8. In the curve of a railway I stretched a line 80 feet in length and the distance from the line to the curve I found to be 9 inches; required the circle's diameter.

$80^2 + .75^2 = 640.5625 \div 2 = 320.28$, etc., feet, the diameter.

To Find the Length of Any Arc of a Circle.

RULE.—*From eight times the chord of half the arc subtract the chord of the whole arc, and one-third of the remainder will be the length, nearly.*

Required the length of an arc, the chord of half the arc being $8\frac{1}{2}$ feet and chord of whole arc 16 feet 8 inches.

$8.5 \times 8 = 68.0 - 16.666 = \frac{41.334}{3} = 13.778$ cubic feet, the length of the arc.

To Find the Area of the Sector of a Circle.

RULE.—*Multiply the length of the arc by half the length of the radius.*

The length of the arc equals $9\frac{1}{2}$ inches and the radii equal each 7 inches; required the area.

$9.5 \times 3.5 = 33.25$ inches, the area.

To Find the Area of a Segment of a Circle.

RULE.—*Find the area of a sector whose arc is equal to that of the given segment, and if it be less than a semicircle subtract the area of the triangle formed by the chord of segment and radii of its extremities; but if more than a semicircle add area of triangle to the area of the sector, and the remainder or sum is the area of the segment.*

To Find the Area of the Space Contained Between Two Concentric Circles or the Area of a Circular Ring.

RULE I.—*Multiply the sum of the inside and outside diameters by their difference and by .7854; the product is the area.*

RULE 2.—*The difference of the area of the two circles will be the area of the ring or space.*

Suppose the external circle equal 4 feet and the internal circle $2\frac{1}{2}$ feet, required the area of space contained between them or area of a ring.

$4 + 2.5 = 6.5$ and $4 - 2.5 = 1.5$, hence, $6.5 \times 1.5 \times .7854 = 7.65$ feet, the area; or,

The area of 4 feet is 12.566; the area of 2.5 is 4.9081. (See table of areas of circles.)

$12.566 - 4.9081 = 7.6579$, the area.

To Find the Area of an Ellipse or Oval.

RULE.—*Multiply the diameters together and their product by .7854.*

An oval is 20 x 15 inches, what are its superficial contents?

$20 \times 15 \times .7854 = 235.62$ inches, the area.

To Find the Circumference of an Ellipse or Oval.

RULE.—*Multiply half the sum of the two diameters by 3.1416 and the product will be the circumference.*

EXAMPLE.—An oval is 20 x 15 inches, what is the circumference.

$\frac{20 + 15}{2} = 17.5 \times 3.1416 = 54.978$ inches, the circumference.

OF CYLINDERS.

To Find the Convex Surface of a Cylinder.

RULE.—*Multiply the circumference by the height or length, the product will be the surface.*

EXAMPLE.—The circumference of a cylinder is 6 feet

4 inches and its length 15 feet, required the convex face.

$$6.333 \times 15 = 94.995 \text{ square feet, the surface.}$$

OF CONES AND PYRAMIDS

To Find the Convex Surface of a Right Cone or Pyramid.

RULE.—Multiply the circumference of the base by the slant height and half the product is the slant surface; if the surface of the entire figure is required, add the area of the base to the convex surface.

EXAMPLE.—The base of a cone is 5 feet diameter the slant height is 7 feet, what is the convex surface?

$$5 \times 3.1416 = 15.70 \text{ circumference of the base}$$

$$\frac{15.70 \times 7}{2} = 54.95 \text{ square feet, the convex surface.}$$

To Find the Convex Surface of a Frustum of a Cone or Pyramid.

RULE.—Multiply the sum of the circumference of two ends by the slant height and half the product will be the slant surface.

The diameter of the top of the frustum of a cone is 3 feet, the base 5 feet, the slant height 7 feet 3 inches required the slant surface.

$$9.42 + 15.7 = \frac{25.12 \times 7.25}{2} = 91.06 \text{ square feet, surface.}$$

OF SPHERES.

To Find the Convex Surface of a Sphere or Globe.

RULE.—Multiply the diameter of the sphere by its circumference and the product is its surface; or,

Multiply the square of the diameter by 3.1416; the product is the surface.

What is the convex surface of a globe $6\frac{1}{2}$ feet in diameter?

$6.5 \times 3.1416 \times 6.5 = 132.73$ square feet; or, $6.5^2 = 42.25 \times 3.1416 = 132.73$ square feet, the convex surface.

MENSURATION OF SOLIDS AND CAPACITIES OF BODIES.

To Find the Solidity or Capacity of Any Figures in the Cubical Form.

RULE.—Multiply the length of any one side by its breadth and by the depth or distance to its opposite side, and the product is the solidity in equal terms of measurement.

EXAMPLE.—The side of a cube is 20 inches; what is its solidity?

$20 \times 20 \times 20 = 8000$ cubic inches, or 4.6296 cubic feet, nearly.

A rectangular tank is in length 6 feet, in breadth $4\frac{1}{2}$ feet and its depth 3 feet; required its capacity in cubic feet; also its capacity in United States standard gallons.

$6 \times 4.5 \times 3 = 81$ cubic feet; $81 \times 1728 = 139,968 \div 231 = 605.92$ gallons.

OF CYLINDERS.

To Find the Solidity of Cylinders.

RULE.—Multiply the area of the base by the hight and the product is its solidity.

EXAMPLE.—The base of a cylinder is 18 inches and the product is its solidity.

$$18^2 \times .7854 \times 40 = 10,178.7840 \text{ cubic inches.}$$

To Find the Contents in Gallons or Cylindrical Vessels.

RULE.—Take the dimensions in inches and decimal parts of an inch. Square the diameter, multiply it by the hight, then multiply the product by .0034 for wine gallons, or by .002785 for beer gallons.

EXAMPLE.—How many United States gallons will a cylinder contain whose diameter is 18 inches and length 30 inches?

$$18^2 \times 30 = 9720 \times .0034 = 33.04, \text{ etc., gallons.}$$

OF CONES AND PYRAMIDS.

To Find the Solidity of a Cone or a Pyramid.

RULE.—Multiply the area of the base by the perpendicular hight and one-third the product will be the solidity.

EXAMPLE.—The base of a cone is $2\frac{1}{4}$ feet and the hight is $3\frac{3}{4}$ feet, what is the solidity?

$$\frac{2.25 \times .7854 \times 3.75}{3} = 497 \text{ cubic feet, the solidity.}$$

To Find the Solidity of the Frustum of a Cone.

RULE.—*To the product of the diameters of the ends add one-third the square of the difference of the diameters; multiply the sum by .7854 and the product will be the mean area between the ends, which multiplied by the perpendicular height of frustum gives the solidity.*

EXAMPLE.—The diameter of the large end of a frustum of a cone is 10 feet, that of the smaller end is 6 feet and the perpendicular height 12 feet, what is its solidity?

$10 - 6 = 4^2 = 16 \div 3 = 5.333$ square of difference of ends; and $10 \times 6 + 5.333 = 65.333 \times .7854 \times 12 = 615.75$ cubic feet, the solidity.

To Find the Contents in U. S. Standard Gallons of the Frustum of a Cone.

RULE.—*To the product of the diameters, in inches and decimal parts of an inch, of the ends, add one-third the square of the difference of the diameters. Multiply the sum by the perpendicular height in inches and decimal parts of an inch and multiply that product by .0034 for wine gallons, and by .002785 for beer gallons.*

EXAMPLE.—The diameter of the large end of a frustum of a cone is 8 feet, that of the smaller end is 4 feet and the perpendicular height 10 feet; what are the contents in United States standard gallons?

$96 - 48 = 48^2 = 2304 \div 3 = 768$; $96 \times 48 + 768 = 5376 \times 120 \times .0034 = 2193.4$ gallons.

To Find the Solidity of the Frustum of a Pyramid.

RULE.—*Add to the areas of the two ends of the frustum the square root of their product, and this sum multi-*

plied by one-third of the perpendicular hight will give the solidity.

EXAMPLE.—What is the solidity of a hexagonal pyramid, a side of the large end being 12 feet, one of the smaller ends 6 feet and the perpendicular hight 8 feet?

$$374.122 + 93.53 = \sqrt[3]{34.991.63} = 590.811; 374.122 + 93.53 \div 590.811 = \frac{1058.463 \times 8}{3} = 2822.568 \text{ cubic feet, solidity.}$$

To Find the Solidity of a Sphere.

RULE.—Multiply the cube of the diameter by .5236 and the product is the solidity.

EXAMPLE.—What is the solidity of a sphere, the diameter being 20 inches?

$$20^3 = 8000 \times .5236 = 4188.8 \text{ cubic inches, the solidity.}$$

TABLES, RULES AND RECIPES.

BLACK SHEET IRON.

Black Sheets are rolled to the following Standard Gauges adopted by the United States, taking effect July 1, 1893.

Number of gauge.	THICKNESS.		WEIGHT.	
	Approximate thickness in fractions of an inch.	Approximate thickness in decimal parts of an inch.	Weight per square foot in ounces avoirdupois.	Weight per square foot in pounds avoirdupois.
10.....	9-64	.140625	90	5.625
11.....	1-8	.125	80	5.
12.....	7-64	.109375	70	4.375
13.....	3-32	.09375	60	3.75
14.....	5-64	.078125	50	3.125
15.....	9-128	.0703125	45	2.8125
16.....	1-16	.0625	40	2.5
17.....	9-160	.05625	36	2.25
18.....	1-20	.05	32	2.
19.....	7-160	.04375	28	1.75
20.....	3-80	.0375	24	1.50
21.....	11-320	.034375	22	1.375
22.....	1-32	.03125	20	1.25
23.....	9-320	.028125	18	1.125
24.....	1-40	.025	16	1.
25.....	7-320	.021875	14	.875
26.....	3-160	.01875	12	.75
27.....	11-640	.0171875	11	.6875
28.....	1-64	.015625	10	.625
29.....	9-640	.0140625	9	.5625
30.....	1-80	.0125	8	.5
31.....	7-640	.0109375	7	.4375
32.....	13-1280	.01015625	6½	.40625

A variation of 2½ per cent. either way is allowed.

PLATE IRON.

The following table gives the weight per square foot for iron plates 1-16 inch up to ½ inch thick.

Thickness.	Weight in lbs.	Thickness.	Weight in lbs.
1-16	2.50	5-16	12.50
1-8	5.00	3-8	15.00
3-16	7.50	7-16	17.50
1-4	10.00	1-2	20.00

Tables, Rules and Recipes.

WEIGHT OF SHEET LEAD.

The thickness of lead is in common determined or understood by the weight, the unit being that of a square or superficial foot; thus:

4 lbs. lead is 1-16 inch in thickness; 6 do. 1-10 do.; 7½ do. 1-8 do.; 11 do. 3-16 do.; 15 do. 1-4 do.

DECIMALS EQUIVALENT TO THE FRACTIONAL PARTS OF A POUND.

.03125	½ oz.	.28125	4½ oz.	.53125	8½ oz.	.78125	12½ oz.
.0625	1 "	.3125	5 "	.5625	9 "	.8125	13 "
.09375	1½ "	.34375	5½ "	.59375	9½ "	.84375	13½ "
.125	2 "	.375	6 "	.625	10 "	.875	14 "
.15625	2½ "	.40625	6½ "	.65625	10½ "	.90625	14½ "
.1875	3 "	.4375	7 "	.6875	11 "	.9375	15 "
.21875	3½ "	.46875	7½ "	.71875	11½ "	.96875	15½ "
.25	4 "	.5	8 "	.75	12 "	1.	16 "

DECIMALS EQUIVALENT TO THE FRACTIONAL PARTS OF AN INCH WHEN DIVIDED INTO 32 PARTS; LIKEWISE THE DECIMALS EQUIVALENT TO THE FRACTIONAL PARTS OF A FOOT.

Decimals.	Parts of an inch.	Decimals.	Parts of an inch.	Decimals.	Parts of a foot.
.03125	1-32	.53125	½ and 1-32	.01041	⅛
.0625	1-16	.5625	½ and 1-16	.02083	¼
.09375	3-32	.59375	½ and 3-32	.03125	⅜
.125	¼	.625	⅝	.04166	½
.15625	⅓ and 1-32	.65625	⅝ and 1-32	.05208	⅝
.1875	⅓ and 1-16	.6875	⅝ and 1-16	.0625	¾
.21875	⅓ and 3-32	.71875	⅝ and 3-32	.07291	⅞
.25	¼	.75	¾	.0833	1
.28125	¼ and 1-32	.78125	¾ and 1-32	.1666	2
.3125	¼ and 1-16	.8125	¾ and 1-16	.25	3
.34375	¼ and 3-32	.84375	¾ and 3-32	.3333	4
.375	⅜	.875	⅞	.4166	5
.40625	⅜ and 1-32	.90625	⅞ and 1-32	.5	6
.4375	⅜ and 1-16	.9375	⅞ and 1-16	.5833	7
.46875	⅜ and 3-32	.96875	⅞ and 3-32	.6666	8
.5	½	1.	1 inch.	.75	9
				.8333	10
				.9166	11

TO ASCERTAIN THE WEIGHTS OF PIPES OF VARIOUS METALS,
AND ANY DIAMETER REQUIRED.

Thick. Wrought				Thick. Wrought			
Inch.	iron.	Copper.	Lead.	Inch.	iron.	Copper.	Lead.
1-32	.326	.38	.483	5-32	1.627	1.9	2.417
1-16	.653	.76	.967	3-16	1.95	2.28	2.9
3-32	.976	1.14	1.45	7-32	2.277	2.66	3.383
1-8	1.3	1.52	1.933	1-4	2.6	3.04	3.867

RULE.—To the interior diameter of the pipe, in inches, add the thickness of the metal; multiply the sum by the decimal number opposite the required thickness and under the metal's name; also by the length of the pipe in feet; and the product is the weight of the pipe in pounds.

1. Required the weight of a copper pipe whose interior diameter is $2\frac{1}{2}$ inches, its length 20 feet, and the metal $\frac{1}{8}$ inch in thickness.

$$2.25 + .125 = 2.375 \times 1.52 \times 20 = 72.2 \text{ pounds.}$$

WEIGHT OF GALVANIZED SHEETS.

Ounces per square foot.			Ounces per square foot.			Ounces per square foot.		
No. 14.....	.52½		No. 20.....	.26½		No. 26.....	.14½	
No. 15.....	.47½		No. 21.....	.24½		No. 27.....	.13½	
No. 16.....	.42½		No. 22.....	.22½		No. 28.....	.12½	
No. 17.....	.38½		No. 23.....	.20½		No. 29.....	.11½	
No. 18.....	.34½		No. 24.....	.18½		No. 30.....	.10½	
No. 19.....	.30½		No. 25.....	.16½				

ORDINARY DIMENSIONS OF GALVANIZED SHEETS.

Widths	40	38	36	34	32	30	28	26	24	22	20
Gauges.	Lengths.										
No. 14.....	96	96	96	96	96	96	96	96	96
Nos. 16 to 22....	120	120	120	120	120	120	120	120	120	120	120
Nos. 23 and 24....	96	96	96	96	108	120	120	120	120	108	108
Nos. 25 to 28....	96	96	108	120	120	120	120	108	108
Nos. 29 and 30....	96	96	96	96

WEIGHT PER FOOT OF LEAD PIPE.

Inside diam- eter. Ins.	AAA Brook- lyn.		AA Ex. strong.		A Strong.		B Medium.		C Light.		D Ex. light.		E Foun- tain.	
	Lb.	Oz.	Lb.	Oz.	Lb.	Oz.	Lb.	Oz.	Lb.	Oz.	Lb.	Oz.	Lb.	Oz.
$\frac{3}{8}$	1	12	1	8	1	4	1	0	0	12	0	10	1	7
7-16	1	0	0	13
$\frac{1}{2}$	3	0	2	0	1	12	1	4	1	0	0	12	0	9
$\frac{5}{8}$	3	8	2	12	2	8	2	0	1	8	1	0	0	12
$\frac{3}{4}$	4	12	3	8	3	0	2	4	1	12	1	4	1	0
1	6	0	4	12	4	0	3	4	2	8	2	0	1	8
$1\frac{1}{4}$	6	12	5	12	4	12	3	12	3	0	2	8	2	0
$1\frac{1}{2}$	8	8	7	8	6	8	5	0	4	4	3	8	3	0
$1\frac{3}{4}$	10	0	8	8	7	0	6	0	5	0	4	0	0	0
2	11	12	9	0	8	0	7	0	6	0	4	12	.	..

NET WEIGHT PER BOX TIN PLATES.

Basis 10 x 14, 225 sheets; or, 14 x 20, 112 sheets.

Trade term.....	80 lb.	85 lb.	90 lb.	95 lb.	100 lb.	100 lb.	IC	IXL	IX	IXX	IXXX	IXXXX
Approximate wire gauge	No. 34	No. 33	No. 32	No. 31½	No. 31	No. 30	No. 28½	No. 28	No. 27	No. 26	No. 25	No. 25
Weight per box, pounds.....	85	85	90	95	100	107	128	135	156	176	196	196
Size of Sheets												
sheets, per box.												
10 x 14	80	85	90	95	100	107	128	135	156	176	196	196
14 x 20	80	85	90	95	100	107	128	135	156	176	196	196
20 x 28	160	170	180	190	200	214	256	270	312	352	392	392
10 x 20	225	114	129	136	143	153	183	193	223	251	280	280
11 x 11	225	69	78	82	86	92	111	117	135	152	169	169
11 x 22	225	138	147	156	164	172	184	222	234	270	304	330
11½ x 23	225	151	161	170	179	189	202	242	255	295	333	370
12 x 12	225	82	93	98	103	110	132	139	160	181	202	202
12 x 24	112	82	93	98	103	110	132	139	160	181	202	202
13 x 13	225	97	103	109	115	121	129	154	163	188	212	236
13 x 26	112	97	103	109	115	121	129	154	163	188	212	236
14 x 14	225	112	119	126	133	140	150	179	189	218	246	274
14 x 28	112	112	119	126	133	140	150	179	189	218	246	274
15 x 15	225	129	137	145	153	161	172	206	217	251	283	315
15 x 16	225	146	155	165	174	183	196	234	247	285	322	358
17 x 17	225	165	175	186	196	206	221	264	279	322	363	405
18 x 18	112	93	104	110	116	124	148	156	180	204	227	227
19 x 19	112	103	110	116	122	129	138	165	174	201	227	253
20 x 20	112	114	121	129	136	143	153	183	193	223	251	280
21 x 21	112	126	134	142	150	158	169	202	213	246	277	309
22 x 22	112	138	147	156	164	172	184	221	234	270	304	339

NET WEIGHT PER BOX TIN PLATES.

Basis 10 x 14, 225 sheets; or, 14 x 20, 112 sheets.

Trade term.....	80 lb.	85 lb.	90 lb.	95 lb.	100 lb.	IC	IXL	IX	IXX	IXXX	IXXXX
Approximate wire gauge	No. 34	No. 33	No. 32	No. 31½	No. 31	No. 30	No. 28½	No. 28	No. 27	No. 26	No. 25
Weight per box, pounds	80	85	90	95	100	107	128	135	156	176	196
Size of Sheets sheets, per box.											
23 x 23	151	161	170	179	189	202	242	255	295	333	370
24 x 24	164	175	185	195	204	220	263	278	321	362	404
26 x 26	193	205	217	229	241	258	309	326	377	424	472
13½ x 19½	75	80	85	89	94	100	120	127	147	165	183
14 x 18¾	83	88	93	98	103	110	132	139	161	182	202
14 x 19¼	83	88	93	98	103	110	132	139	161	182	202
14 x 21	84	89	95	100	105	112	134	142	164	185	206
14 x 22	88	94	99	105	110	118	141	149	172	194	216
15 x 21	80	95	101	107	113	120	144	152	176	197	220
16 x 20	91	97	103	109	114	122	146	154	178	201	224
14 x 31	124	132	140	147	155	166	198	209	242	273	304

Approximate wire gauge D plates.....	No. 28	No. 25	No. 24	No. 23	No. 22
12½ x 17D	94	122	142	162	182
17 x 25D	94	122	142	162	182
15 x 21D	140	181	211	241	271

Taggers iron and tin.	10 x 14		14 x 20		20 x 28		20 x 40	
	Sheets	Pounds	Sheets	Pounds	Sheets	Pounds	Sheets	Pounds
No. 30 W G	per box.	per box.	per box.	per box.	per box.	per box.	per box.	per box.
No. 32 W G	300	112	112	107	112	214	79	224
No. 34 W G	360	112	128	112	128	224	79	180
No. 36 W G	450	112	180	112	150	224	79	160
No. 38 W G		112	225	112	180	224	241	271
					225	225		

SHEET ZINC.

Numbers ...	4	5	6	7	8	9	10	11	12	13	14	15	16	17	18	19	20	21	22	
Weight per sq. foot..	.30	.37	.45	.52	.60	.67	.75	.90	1.05	1.20	1.35	1.50	1.68	1.87	2.06	2.25	2.62	3.00	3.37	
Approximate thickness in inches...	.008	.010	.012	.014	.016	.018	.020	.024	.028	.032	.036	.040	.045	.050	.055	.060	.070	.080	.090	
Size of Sq.ft. sheet, per sht.																				
APPROXIMATE WEIGHT PER SHEET.																				
24 x 84	14.	4.2	5.2	6.3	7.3	8.4	9.4	10.5	12.6	14.7	16.8	18.9	21.	23.5	26.2	28.9	31.5	36.7	42.	47.2
26 x 84	15.2	4.6	5.6	6.9	7.9	9.1	10.2	11.4	13.7	16.	18.3	20.5	22.8	25.6	28.4	31.3	34.2	39.9	45.6	51.2
28 x 84	16.3	4.9	6.	7.4	8.5	9.8	10.9	12.2	14.7	17.1	19.6	22.	24.5	27.4	30.5	33.6	36.7	42.7	48.9	54.9
30 x 84	17.5	5.3	6.5	7.9	9.1	10.5	11.8	13.2	15.8	18.4	21.	23.6	26.2	29.4	32.8	36.1	39.4	45.8	52.5	59.
32 x 84	18.7	5.6	6.9	8.4	9.7	11.2	12.6	14.1	16.9	19.7	22.5	25.3	28.8	31.4	35.	38.5	42.	49.	56.1	63.
34 x 84	19.9	6.0	7.4	9.	10.4	12.	13.4	15.	18.	20.9	23.9	26.9	29.9	33.4	37.2	41.	44.8	52.2	59.7	67.
36 x 84	21.	6.3	7.8	9.5	10.9	12.6	14.1	15.8	18.9	22.	25.2	28.4	31.5	35.3	39.3	43.3	47.2	55.	63.	70.8
36 x 96	24.	7.2	8.9	10.8	12.5	14.4	16.1	18.	21.6	25.2	28.8	32.4	36.	40.3	44.9	49.5	54.	62.8	72.	80.9
36 x 108	27.	8.1	10.	12.2	14.1	16.2	18.1	20.3	24.3	28.4	32.4	36.5	40.5	45.4	50.5	55.6	60.7	70.7	81.	91.
40 x 84	23.4	7.	8.7	10.6	12.2	14.1	15.7	17.6	21.	24.6	28.1	31.6	35.1	39.3	43.8	48.2	52.6	61.3	70.2	78.8
40 x 96	26.8	8.	9.9	12.1	14.	16.1	18.	20.1	24.1	28.1	32.2	36.2	40.2	45.	50.1	55.2	60.3	70.2	80.4	90.3
44 x 84	25.7	7.7	9.5	11.6	13.4	15.4	17.2	19.3	23.1	27.	30.8	34.7	38.6	43.2	48.1	53.	57.8	67.4	77.1	86.6
44 x 90	28.7	8.6	10.6	12.9	14.9	17.2	19.2	21.5	25.8	30.1	34.4	38.7	43.	48.2	53.7	59.1	64.6	75.2	86.1	96.7
48 x 84	28.	8.4	10.4	12.6	14.6	16.8	18.8	21.	25.2	29.4	33.6	37.8	42.	47.	52.4	57.7	63.	73.4	84.	94.4
48 x 96	32.	9.6	11.9	14.4	16.7	19.2	21.5	24.	28.8	33.6	38.4	43.2	48.	53.8	59.9	65.9	72.	83.9	96.	107.8
50 x 108	37.5	11.3	13.9	16.9	19.5	22.5	25.1	28.2	33.8	39.3	45.	50.7	56.3	63.	70.1	77.3	84.4	98.3	112.5	126.4
52 x 84	30.4	9.1	11.3	13.7	15.8	18.3	20.4	22.8	27.4	31.9	36.5	41.	45.6	51.	56.9	62.6	68.4	79.6	91.2	102.5

Casks average about 600 pounds each. No. 4 to No. 17. Boxes average about 500 pounds. No. 18 and heavier.

RELATIVE WEIGHTS OF ALUMINUM AND COPPER SHEETS.

ROLLED ALUMINUM has a specific gravity of 2.72. One cubic foot weighs $169\frac{510}{1000}$ lbs. One square foot of one inch thick weighs $14\frac{135}{1000}$ lbs. Rolled Copper is 3.283 times heavier than similar sections of Rolled Aluminum.

Stub's gauge (nearest) No.	Thickness in decimal parts of 1 inch.	Oz. per square foot of copper.	Oz. per square foot of aluminum of same thickness.	Sheets 14 x 48 weight in pounds of copper.	Sheets 14 x 48 weight in pounds of aluminum of same thickness.	Sheets 24 x 48 weight in pounds of copper.	Sheets 24 x 48 weight in pounds of aluminum of same thickness.	Sheets 30 x 60 weight in pounds of copper.	Sheets 30 x 60 weight in pounds of aluminum of same thickness.	Sheets 36 x 72 weight in pounds of copper.	Sheets 36 x 72 weight in pounds of aluminum of same thickness.	Sheets 48 x 72 weight in pounds of copper.	Sheets 48 x 72 weight in pounds of aluminum of same thickness.
35	.00537	4	1.22	1.16	0.35	2	0.61	3.12	0.96	4.50	1.38	6	1.83
33	.00806	6	1.83	1.75	0.53	3	0.92	4.68	1.43	6.75	2.06	9	2.75
31	.0107	8	2.44	2.33	0.71	4	1.22	6.25	1.91	9	2.75	12	3.65
29	.0134	10	3.05	2.91	0.89	5	1.53	7.81	2.38	11.25	3.43	15	4.57
27	.0161	12	3.66	3.50	1.07	6	1.83	9.37	2.86	13.50	4.12	18	5.49
26	.0183	14	4.27	4.08	1.25	7	2.14	10.93	3.33	15.75	4.80	21	6.40
24	.0215	16	4.88	4.66	1.42	8	2.44	12.50	3.81	18	5.49	24	7.32
23	.0242	18	5.49	5.25	1.60	9	2.75	14.06	4.29	20.25	6.17	27	8.23
22	.0269	20	6.10	5.83	1.78	10	3.05	15.62	4.76	22.50	6.86	30	9.14
21	.0322	24	7.32	7	2.14	12	3.66	18.75	5.72	27	8.23	36	11.00
19	.0430	32	9.75	9.33	2.85	16	4.88	25	7.62	36	11.00	48	14.70
18	.0538	40	12.20	11.66	3.56	20	6.10	31.25	9.52	45	13.75	60	18.30
16	.0645	48	14.65	14	4.27	24	7.32	37.50	11.45	54	16.50	72	22.00
15	.0754	56	17.10	16.33	4.98	28	8.53	43.75	13.35	63	19.20	84	25.60
14	.0860	64	19.50	18.66	5.69	32	9.75	50	15.30	72	21.95	96	29.30
13	.095	70	21.35	35	10.70	55	16.80	79	24.10	105	32.00
12	.109	81	24.70	40½	12.40	63	19.20	91	27.75	122	37.20
11	.120	89	27.15	44½	13.60	70	21.35	100	30.50	134	40.85
9	.134	100	30.50	50	15.30	78	23.80	112	34.20	150	45.70
9	.148	110	33.55	55	16.80	86	26.20	124	37.80	165	50.30
8	.165	123	37.50	61	18.60	96	29.30	138	42.10	184	56.10
7	.180	134	40.85	67	20.40	105	32.00	151	46.00	201	61.30
6	.203	151	46.00	75½	23.00	118	36.00	170	51.80	227	69.20
5	.220	164	50.00	82	25.00	128	39.00	184	56.10	246	75.00
4	.238	177	53.95	88½	27.00	138	42.10	199	60.70	266	81.10
3	.259	193	64.30	96	29.30	151	46.00	217	66.10	289	88.10
2	.284	211	67.95	105½	32.20	165	50.30	238	72.50	317	96.60
1	.300	223	77.10	111½	34.00	174	53.10	251	76.50	335	102.20
0	.340	253	126½	38.60	198	60.40	285	86.90	380	116.00

One ounce per square foot aluminum sheet is 0.0044 inch thick and corresponds to about No. 37 B. & S. gauge.

SHEET COPPER.

Official table adopted by the Association of Copper Manufacturers of the United States.

Rolled copper has specific gravity of 8.93. One cubic foot weighs 558¹²⁵/₁₀₀₀ pounds. One square foot, of 1 inch thick, weighs 46⁵¹/₁₀₀ pounds.

Stubs' gauge (nearest) number.	Thickness in decimal parts of 1 inch.	Ounces per square foot.	Sheets 14 x 48, weight in lbs.	Sheets 24 x 48, weight in lbs.	Sheets 30 x 60, weight in lbs.	Sheets 36 x 72, weight in lbs.	Sheets 48 x 72, weight in lbs.
35	.00537	4	1.16	2	3.12	4.50	6
33	.00806	6	1.75	3	4.68	6.75	9
31	.0107	8	2.33	4	6.25	9	12
29	.0134	10	2.91	5	7.81	11.25	15
27	.0161	12	3.50	6	9.37	13.50	18
26	.0188	14	4.08	7	10.93	15.75	21
24	.0215	16	4.66	8	12.50	18	24
23	.0242	18	5.25	9	14.06	20.25	27
22	.0269	20	5.83	10	15.62	22.50	30
21	.0322	24	7	12	18.75	27	36
19	.0430	32	9.33	16	25	36	48
18	.0538	40	11.66	20	31.25	45	60
16	.0645	48	14	24	37.50	54	72
15	.0754	56	16.33	28	43.75	63	84
14	.0860	64	18.66	32	50	72	96
13	.095	70	35	55	79	105
12	.109	81	40 ¹ / ₂	63	91	122
11	.120	89	44 ¹ / ₂	70	100	134
10	.134	100	50	78	112	150
9	.148	110	55	86	124	165
8	.165	123	61	96	138	184
7	.180	134	67	105	151	201
6	.203	151	75 ¹ / ₂	118	170	227
5	.220	164	82	128	184	246
4	.238	177	88 ¹ / ₂	138	199	266
3	.259	193	96	151	217	289
2	.284	211	105 ¹ / ₂	165	238	317
1	.300	223	111 ¹ / ₂	174	251	335
0	.340	253	126 ¹ / ₂	198	285	380

TABLES
 OF THE
CIRCUMFERENCES OF CIRCLES,
 TO THE
 NEAREST FRACTION OF PRACTICAL MEASUREMENT;
 ALSO,
 THE AREAS OF CIRCLES, IN INCHES AND DECIMAL PARTS,
 LIKEWISE IN FEET AND DECIMAL PARTS, AS
 MAY BE REQUIRED.

Rules that may render the following tables more generally useful.

1. Any of the areas in inches, multiplied by .052, or the areas in feet multiplied by 7.48, the product is the number of gallons at 1 foot in depth.

2. Any of the areas in feet, multiplied by .03704, the product equals the number of cubic yards at 1 foot in depth.

Dia. in inch.	Circum. in inch.	Area in sq. inch.	Side of = sq.	Dia. in inch.	Cir. in ft. in.	Area in sq. inch.	Area in sq. ft.
1-16	.196	.0030	.0554	1 in.	3 $\frac{1}{8}$.7854	$\frac{7}{8}$
1-8	.392	.0122	.1107	1 $\frac{1}{8}$	3 $\frac{1}{2}$.9940	$\frac{7}{8}$ and 3-32
3-16	.589	.0276	.1661	1 $\frac{1}{4}$	3 $\frac{7}{8}$	1.227	1 in.
1-4	.785	.0490	.2115	1 $\frac{3}{8}$	4 $\frac{1}{4}$	1.484	1 3-16
5-16	.981	.0767	.2669	1 $\frac{1}{2}$	4 $\frac{3}{4}$	1.767	1 5-16
3-8	1.178	.1104	.3223	1 $\frac{3}{4}$	5 $\frac{1}{8}$	2.074	1 7-16
7-16	1.374	.1503	.3771	1 $\frac{3}{4}$	5 $\frac{1}{2}$	2.405	1 9-16
				1 $\frac{7}{8}$	5 $\frac{7}{8}$	2.761	1 11-16
1-2	1.570	.1963	.4331	2 in.	6 $\frac{1}{4}$	3.141	1 $\frac{3}{4}$
9-16	1.767	.2485	.4995	2 $\frac{1}{8}$	6 $\frac{3}{8}$	3.546	1 $\frac{7}{8}$
5-8	1.963	.3068	.5438	2 $\frac{1}{4}$	7	3.976	2 in.
11-16	2.159	.3712	.6093	2 $\frac{3}{8}$	7 $\frac{3}{8}$	4.430	2 $\frac{1}{8}$
3-4	2.356	.4417	.6646	2 $\frac{1}{2}$	7 $\frac{3}{4}$	4.908	2 3-16
13-16	2.552	.5185	.7200	2 $\frac{5}{8}$	8 $\frac{1}{4}$	5.412	2 5-16
7-8	2.748	.6013	.7754	2 $\frac{3}{4}$	8 $\frac{3}{8}$	5.939	2 7-16
15-16	2.945	.6903	.8308	2 $\frac{7}{8}$	9	6.491	2 9-16

Dia. in. in.	Cir. in.	Area in sq. in.	Side of = sq.	Dia. in in.	Cir. in ft. in.	Area in sq. in.	Area in sq. ft.
3 in.	9 ³ / ₈	7.068	2 ³ / ₈	10 in.	2 7 ³ / ₈	78.540	.5497
3 ¹ / ₈	9 ¹ / ₄	7.669	2 ¹ / ₄	10 ¹ / ₈	2 7 ¹ / ₄	80.515	.5636
3 ¹ / ₄	10 ¹ / ₄	8.295	2 ⁷ / ₈	10 ¹ / ₄	2 8 ¹ / ₄	82.516	.5776
3 ³ / ₈	10 ³ / ₈	8.946	3 in.	10 ³ / ₈	2 8 ¹ / ₂	84.540	.5917
3 ¹ / ₂	11	9.621	3 ¹ / ₈	10 ¹ / ₂	2 8 ⁷ / ₈	86.590	.6061
3 ³ / ₄	11 ³ / ₈	10.320	3 ¹ / ₄	10 ³ / ₄	2 9 ³ / ₈	88.664	.6206
3 ⁷ / ₈	11 ³ / ₄	11.044	3 ³ / ₈	10 ³ / ₄	2 9 ³ / ₄	90.762	.6353
3 ⁷ / ₈	12 ¹ / ₈	11.793	3 7-16	10 ⁷ / ₈	2 10 ¹ / ₈	92.855	.6499
Dia. in inch.	Cir. in ft. in.	Area in sq. inch.	Area in sq. ft.	11 in.	2 10 ¹ / ₂	95.033	.6652
4 in.	1 0 ¹ / ₂	12.566	.0879	11 ¹ / ₈	2 10 ⁷ / ₈	97.205	.6874
4 ¹ / ₈	1 0 ⁷ / ₈	13.364	.0935	11 ¹ / ₄	2 11 ¹ / ₄	99.402	.6958
4 ¹ / ₄	1 1 ¹ / ₈	14.186	.0993	11 ³ / ₈	2 11 ³ / ₈	101.623	.7143
4 ¹ / ₂	1 1 ¹ / ₄	15.033	.1052	11 ¹ / ₂	3 0 ¹ / ₈	103.869	.7290
4 ³ / ₄	1 1 ³ / ₈	15.904	.1113	11 ⁵ / ₈	3 0 ¹ / ₂	106.139	.7429
4 ⁷ / ₈	1 1 ³ / ₄	16.800	.1176	11 ³ / ₄	3 0 ⁷ / ₈	108.434	.7590
4 ⁷ / ₈	1 2 ¹ / ₈	17.720	.1240	11 ⁷ / ₈	3 1 ¹ / ₄	110.753	.7752
4 ⁷ / ₈	1 2 ¹ / ₄	18.665	.1306	12 in.	3 1 ⁵ / ₈	113.097	.7916
5 in.	1 3 ⁵ / ₈	19.635	.1374	12 ¹ / ₈	3 2	115.466	.8082
5 ¹ / ₈	1 4 ¹ / ₈	20.629	.1444	12 ¹ / ₄	3 2 ¹ / ₂	117.859	.8250
5 ¹ / ₄	1 4 ¹ / ₂	21.647	.1515	12 ³ / ₈	3 2 ⁷ / ₈	120.276	.8419
5 ³ / ₈	1 4 ⁷ / ₈	22.690	.1588	12 ¹ / ₂	3 3 ¹ / ₄	122.718	.8590
5 ¹ / ₂	1 5 ¹ / ₄	23.758	.1663	12 ⁵ / ₈	3 3 ³ / ₄	125.185	.8762
5 ⁵ / ₈	1 5 ⁵ / ₈	24.850	.1739	12 ³ / ₄	3 4	127.676	.8937
5 ³ / ₄	1 6	25.967	.1817	12 ⁷ / ₈	3 4 ³ / ₈	130.192	.9113
5 ⁷ / ₈	1 6 ³ / ₈	27.108	.1897	13 in.	3 4 ³ / ₄	132.732	.9291
6 in.	1 6 ³ / ₄	28.274	.1979	13 ¹ / ₈	3 5 ¹ / ₄	135.297	.9470
6 ¹ / ₈	1 7 ¹ / ₄	29.464	.2062	13 ¹ / ₄	3 5 ⁵ / ₈	137.886	.9642
6 ¹ / ₄	1 7 ³ / ₈	30.679	.2147	13 ³ / ₈	3 6	140.500	.9835
6 ³ / ₈	1 8	31.919	.2234	13 ¹ / ₂	3 6 ³ / ₈	143.139	1.0019
6 ¹ / ₂	1 8 ³ / ₈	33.183	.2322	13 ⁵ / ₈	3 6 ³ / ₄	145.802	1.0206
6 ³ / ₄	1 8 ³ / ₄	34.471	.2412	13 ³ / ₄	3 7 ¹ / ₈	148.489	1.0294
6 ⁵ / ₈	1 9 ¹ / ₈	35.784	.2504	13 ⁷ / ₈	3 7 ¹ / ₂	151.201	1.0584
6 ⁷ / ₈	1 9 ¹ / ₂	37.122	.2598	14 in.	3 7 ⁷ / ₈	153.938	1.0775
7 in.	1 10	38.484	.2693	14 ¹ / ₈	3 8 ³ / ₈	156.699	1.0968
7 ¹ / ₈	1 10 ³ / ₈	39.871	.2791	14 ¹ / ₄	3 8 ³ / ₄	159.485	1.1193
7 ¹ / ₄	1 10 ³ / ₄	41.282	.2889	14 ³ / ₈	3 9 ¹ / ₈	162.295	1.1360
7 ³ / ₈	1 11 ¹ / ₈	42.718	.2990	14 ¹ / ₂	3 9 ¹ / ₂	165.130	1.1569
7 ¹ / ₂	1 11 ¹ / ₄	44.178	.3092	14 ³ / ₄	3 9 ⁷ / ₈	167.989	1.1749
7 ⁵ / ₈	1 11 ⁷ / ₈	45.663	.3196	14 ⁵ / ₈	3 10 ¹ / ₄	170.873	1.1961
7 ³ / ₄	2 0 ³ / ₈	47.173	.3299	14 ⁷ / ₈	3 10 ³ / ₄	173.782	1.2164
7 ⁷ / ₈	2 0 ³ / ₄	47.707	.3409	15 in.	3 11 ¹ / ₈	176.715	1.2370
8 in.	2 1 ¹ / ₈	50.265	.3518	15 ¹ / ₈	3 11 ¹ / ₂	179.672	1.2577
8 ¹ / ₈	2 1 ¹ / ₂	51.848	.3629	15 ¹ / ₄	3 11 ⁷ / ₈	182.654	1.2785
8 ¹ / ₄	2 1 ⁷ / ₈	53.456	.3741	15 ³ / ₈	4 0 ¹ / ₄	185.661	1.2996
8 ³ / ₈	2 2 ¹ / ₄	55.088	.3856	15 ¹ / ₂	4 0 ⁵ / ₈	188.692	1.3208
8 ¹ / ₂	2 2 ⁵ / ₈	56.745	.3972	15 ⁵ / ₈	4 1	191.748	1.3422
8 ³ / ₄	2 3	58.426	.4089	15 ³ / ₄	4 1 ¹ / ₂	194.828	1.3637
8 ⁵ / ₈	2 3 ³ / ₈	60.132	.4209	15 ⁷ / ₈	4 1 ⁷ / ₈	197.933	1.3855
8 ⁷ / ₈	2 3 ⁷ / ₈	61.862	.4330	16 in.	4 2 ¹ / ₄	201.062	1.4074
9 in.	2 4 ¹ / ₄	63.617	.4453	16 ¹ / ₈	4 2 ⁵ / ₈	204.216	1.4295
9 ¹ / ₈	2 4 ⁵ / ₈	65.396	.4517	16 ¹ / ₄	4 3	207.394	1.4517
9 ¹ / ₄	2 5	67.200	.4704	16 ³ / ₈	4 3 ³ / ₈	210.597	1.4741
9 ³ / ₈	2 5 ³ / ₈	69.029	.4832	16 ¹ / ₂	4 3 ³ / ₄	213.825	1.4967
9 ¹ / ₂	2 5 ³ / ₄	70.882	.4961	16 ⁵ / ₈	4 4 ¹ / ₄	217.077	1.5195
9 ⁵ / ₈	2 6 ¹ / ₄	72.759	.5093	16 ³ / ₄	4 4 ⁵ / ₈	220.353	1.5424
9 ³ / ₄	2 6 ⁷ / ₈	74.662	.5226	16 ⁷ / ₈	4 5	223.654	1.5655
9 ⁷ / ₈	2 7	76.588	.5361				

Dia. in inch.	Cir. in ft.	Area in sq. inch.	Area in sq. ft.	Dia. in ft.	Cir. in ft.	Area in sq. inch.	Area in sq. ft.			
17 in.	4	5 $\frac{3}{8}$	226.980	1.5888	2	0	6	3 $\frac{3}{8}$	452.290	3.1418
17 $\frac{1}{4}$	4	5 $\frac{3}{4}$	230.330	1.6123	2	0 $\frac{1}{4}$	6	4 $\frac{1}{8}$	461.864	3.2075
17 $\frac{1}{2}$	4	6 $\frac{1}{4}$	233.705	1.6359	2	0 $\frac{1}{2}$	6	4 $\frac{3}{8}$	471.436	3.2731
17 $\frac{3}{8}$	4	6 $\frac{1}{2}$	237.104	1.6597	2	0 $\frac{3}{4}$	6	5 $\frac{1}{4}$	481.106	3.3410
17 $\frac{1}{2}$	4	6 $\frac{3}{4}$	240.528	1.6836	2	1	6	6 $\frac{1}{2}$	490.875	3.4081
17 $\frac{3}{4}$	4	7 $\frac{1}{8}$	243.977	1.7078	2	1 $\frac{1}{4}$	6	7 $\frac{1}{4}$	500.741	3.4775
17 $\frac{3}{4}$	4	7 $\frac{3}{4}$	247.450	1.7321	2	1 $\frac{1}{2}$	6	8 $\frac{1}{8}$	510.706	3.5468
17 $\frac{7}{8}$	4	8 $\frac{1}{8}$	250.947	1.7566	2	1 $\frac{3}{4}$	6	8 $\frac{3}{8}$	520.769	3.6101
18 in.	4	8 $\frac{1}{2}$	254.469	1.7812	2	2	6	9 $\frac{1}{8}$	530.930	3.6870
18 $\frac{1}{8}$	4	8 $\frac{3}{8}$	258.016	1.8061	2	2 $\frac{1}{4}$	6	10 $\frac{1}{8}$	541.189	3.7583
18 $\frac{1}{4}$	4	9 $\frac{1}{4}$	261.587	1.8311	2	2 $\frac{1}{2}$	6	11 $\frac{1}{4}$	551.547	3.8302
18 $\frac{3}{8}$	4	9 $\frac{3}{4}$	265.182	1.8562	2	2 $\frac{3}{4}$	7	0	562.002	3.9042
18 $\frac{1}{2}$	4	10 $\frac{1}{8}$	268.803	1.8816	2	3	7	0 $\frac{3}{4}$	572.556	3.9761
18 $\frac{3}{4}$	4	10 $\frac{1}{4}$	272.447	1.9071	2	3 $\frac{1}{4}$	7	1 $\frac{5}{8}$	583.208	4.0500
18 $\frac{3}{4}$	4	10 $\frac{3}{8}$	276.117	1.9328	2	3 $\frac{1}{2}$	7	2 $\frac{3}{8}$	593.958	4.1241
18 $\frac{7}{8}$	4	11 $\frac{1}{4}$	279.811	1.9586	2	3 $\frac{3}{4}$	7	3 $\frac{1}{8}$	604.807	4.2000
19 in.	4	11 $\frac{5}{8}$	283.529	1.9847	2	4	7	3 $\frac{7}{8}$	615.753	4.2760
19 $\frac{1}{8}$	5	0	287.272	1.9941	2	4 $\frac{1}{4}$	7	4 $\frac{3}{4}$	626.798	4.3521
19 $\frac{1}{4}$	5	0 $\frac{1}{2}$	291.039	2.0371	2	4 $\frac{1}{2}$	7	5 $\frac{1}{2}$	637.941	4.4302
19 $\frac{3}{8}$	5	0 $\frac{3}{8}$	294.831	2.0637	2	4 $\frac{3}{4}$	7	6 $\frac{1}{4}$	649.182	4.5083
19 $\frac{1}{2}$	5	1 $\frac{1}{4}$	298.648	2.0904	2	5	7	7	660.521	4.5861
19 $\frac{3}{4}$	5	1 $\frac{5}{8}$	302.489	2.1172	2	5 $\frac{1}{4}$	7	7 $\frac{1}{8}$	671.958	4.6665
19 $\frac{3}{4}$	5	2	306.355	2.1443	2	5 $\frac{1}{2}$	7	8 $\frac{5}{8}$	683.494	4.7467
19 $\frac{7}{8}$	5	2 $\frac{3}{8}$	310.245	2.1716	2	5 $\frac{3}{4}$	7	9 $\frac{1}{2}$	695.128	4.8274
20 in.	5	2 $\frac{7}{8}$	314.160	2.1990	2	6	7	10 $\frac{1}{4}$	706.860	4.9081
20 $\frac{1}{8}$	5	3 $\frac{1}{4}$	318.099	2.2265	2	6 $\frac{1}{4}$	7	11	718.690	4.9901
20 $\frac{1}{4}$	5	3 $\frac{3}{8}$	322.063	2.2543	2	6 $\frac{1}{2}$	7	11 $\frac{3}{4}$	730.618	5.0731
20 $\frac{3}{8}$	5	4	326.051	2.2822	2	6 $\frac{3}{4}$	8	0 $\frac{5}{8}$	742.644	5.1573
20 $\frac{1}{2}$	5	4 $\frac{3}{8}$	330.064	2.3103	2	7	8	1 $\frac{3}{8}$	754.769	5.2278
20 $\frac{3}{4}$	5	4 $\frac{3}{4}$	334.101	2.3386	2	7 $\frac{1}{4}$	8	2 $\frac{1}{4}$	766.992	5.3264
20 $\frac{3}{4}$	5	5 $\frac{1}{8}$	338.163	2.3670	2	7 $\frac{1}{2}$	8	2 $\frac{7}{8}$	779.313	5.4112
20 $\frac{7}{8}$	5	5 $\frac{1}{2}$	342.250	2.3956	2	7 $\frac{3}{4}$	8	3 $\frac{3}{4}$	791.732	5.4982
21 in.	5	5 $\frac{7}{8}$	346.361	2.4244	2	8	8	4 $\frac{1}{2}$	804.249	5.5850
21 $\frac{1}{8}$	5	6 $\frac{3}{8}$	350.497	2.4533	2	8 $\frac{1}{4}$	8	5 $\frac{3}{8}$	816.865	5.6729
21 $\frac{1}{4}$	5	6 $\frac{3}{4}$	354.657	2.4824	2	8 $\frac{1}{2}$	8	6 $\frac{1}{8}$	829.578	5.7601
21 $\frac{3}{8}$	5	7 $\frac{1}{8}$	358.841	2.5117	2	8 $\frac{3}{4}$	8	6 $\frac{7}{8}$	842.390	5.8491
21 $\frac{1}{2}$	5	7 $\frac{1}{2}$	363.051	2.5412	2	9	8	7 $\frac{5}{8}$	855.300	5.9398
21 $\frac{3}{4}$	5	7 $\frac{3}{4}$	367.284	2.5708	2	9 $\frac{1}{4}$	8	8 $\frac{1}{2}$	868.308	6.0291
21 $\frac{3}{4}$	5	8 $\frac{1}{4}$	371.543	2.6007	2	9 $\frac{1}{2}$	8	9 $\frac{1}{4}$	881.415	6.1201
21 $\frac{7}{8}$	5	8 $\frac{3}{4}$	375.826	2.6306	2	9 $\frac{3}{4}$	8	10	894.619	6.2129
22 in.	5	9 $\frac{1}{8}$	380.133	2.6608	2	10	8	10 $\frac{3}{4}$	907.922	6.3051
22 $\frac{1}{8}$	5	9 $\frac{1}{4}$	384.465	2.6691	2	10 $\frac{1}{4}$	8	11 $\frac{1}{8}$	921.323	6.3981
22 $\frac{1}{4}$	5	9 $\frac{3}{8}$	388.822	2.7016	2	10 $\frac{1}{2}$	9	0 $\frac{3}{8}$	934.822	6.4911
22 $\frac{3}{8}$	5	10 $\frac{1}{4}$	393.203	2.7224	2	10 $\frac{3}{4}$	9	1 $\frac{1}{8}$	948.419	6.5863
22 $\frac{1}{2}$	5	10 $\frac{3}{8}$	397.608	2.7632	2	11	9	1 $\frac{3}{8}$	962.115	6.6815
22 $\frac{3}{4}$	5	11	402.038	2.7980	2	11 $\frac{1}{4}$	9	2 $\frac{1}{8}$	975.908	6.7772
22 $\frac{3}{4}$	5	11 $\frac{1}{2}$	406.493	2.8054	2	11 $\frac{1}{2}$	9	3 $\frac{1}{2}$	989.800	6.8738
22 $\frac{7}{8}$	5	11 $\frac{3}{4}$	410.972	2.8658	2	11 $\frac{3}{4}$	9	4 $\frac{1}{4}$	1003.79	6.9701
23 in.	6	0 $\frac{1}{4}$	415.476	2.8903	3	0	9	5	1017.87	7.0688
23 $\frac{1}{8}$	6	0 $\frac{5}{8}$	420.004	2.9100	3	0 $\frac{1}{4}$	9	5 $\frac{7}{8}$	1032.06	7.1671
23 $\frac{1}{4}$	6	1	424.557	2.9518	3	0 $\frac{1}{2}$	9	6 $\frac{5}{8}$	1046.35	7.2664
23 $\frac{3}{8}$	6	1 $\frac{1}{8}$	429.135	2.9937	3	0 $\frac{3}{4}$	9	7 $\frac{1}{8}$	1060.73	7.3662
23 $\frac{1}{2}$	6	1 $\frac{3}{4}$	433.737	3.0129	3	1	9	8 $\frac{1}{4}$	1075.21	7.4661
23 $\frac{3}{4}$	6	2 $\frac{1}{4}$	438.363	3.0261	3	1 $\frac{1}{4}$	9	9	1089.79	7.5671
23 $\frac{3}{4}$	6	2 $\frac{3}{8}$	443.014	3.0722	3	1 $\frac{1}{2}$	9	9 $\frac{7}{8}$	1104.46	7.6691
23 $\frac{7}{8}$	6	3	447.690	3.1081	3	1 $\frac{3}{4}$	9	10 $\frac{1}{2}$	1119.24	7.7791

D'a. in	Cir. in	Area in	Area in	Dia. in	Cir. in	Area in	Area in				
ft.	in.	sq. inch.	sq. ft.	ft.	in.	sq. inch.	sq. ft.				
3	2	9	11 $\frac{3}{8}$	1134.12	7.8681	4	4	13	7 $\frac{3}{8}$	2123.72	14.748
3	2 $\frac{1}{4}$	10	0 $\frac{1}{4}$	1149.09	7.9791	4	4 $\frac{1}{4}$	13	8 $\frac{1}{8}$	2144.19	14.890
3	2 $\frac{1}{2}$	10	0 $\frac{1}{2}$	1164.16	8.0846	4	4 $\frac{1}{2}$	13	8 $\frac{3}{8}$	2164.75	15.033
3	2 $\frac{3}{4}$	10	1 $\frac{1}{4}$	1179.32	8.1891	4	4 $\frac{3}{4}$	13	9 $\frac{1}{4}$	2185.42	15.176
3	3	10	2 $\frac{1}{2}$	1194.59	8.2951	4	5	13	10 $\frac{1}{2}$	2206.18	15.320
3	3 $\frac{1}{4}$	10	3 $\frac{1}{4}$	1209.95	8.4026	4	5 $\frac{1}{4}$	13	11 $\frac{1}{4}$	2227.05	15.465
3	3 $\frac{1}{2}$	10	4	1225.42	8.5091	4	5 $\frac{1}{2}$	14	0	2248.01	15.611
3	3 $\frac{3}{4}$	10	4 $\frac{7}{8}$	1240.98	8.6171	4	5 $\frac{3}{4}$	14	0 $\frac{7}{8}$	2269.06	15.757
3	4	10	5 $\frac{1}{4}$	1256.64	8.7269	4	6	14	1 $\frac{1}{8}$	2290.22	15.904
3	4 $\frac{1}{4}$	10	6 $\frac{3}{8}$	1272.39	8.8361	4	6 $\frac{1}{4}$	14	2 $\frac{3}{8}$	2311.48	16.051
3	4 $\frac{1}{2}$	10	7 $\frac{1}{4}$	1288.25	8.9462	4	6 $\frac{1}{2}$	14	3 $\frac{1}{4}$	2332.83	16.200
3	4 $\frac{3}{4}$	10	8	1304.20	9.0561	4	6 $\frac{3}{4}$	14	4	2354.28	16.349
3	5	10	8 $\frac{3}{4}$	1320.25	9.1686	4	7	14	4 $\frac{3}{4}$	2375.83	16.498
3	5 $\frac{1}{4}$	10	9 $\frac{1}{2}$	1336.40	9.2112	4	7 $\frac{1}{4}$	14	5 $\frac{1}{2}$	2397.48	16.649
3	5 $\frac{1}{2}$	10	10 $\frac{3}{8}$	1352.65	9.3936	4	7 $\frac{1}{2}$	14	6 $\frac{2}{8}$	2419.22	16.800
3	5 $\frac{3}{4}$	10	11 $\frac{1}{8}$	1369.00	9.5061	4	7 $\frac{3}{4}$	14	7 $\frac{1}{8}$	2441.07	16.951
3	6	10	11 $\frac{3}{8}$	1385.44	9.6212	4	8	14	7 $\frac{3}{4}$	2463.01	17.104
3	6 $\frac{1}{4}$	11	0 $\frac{3}{4}$	1401.98	9.7364	4	8 $\frac{1}{4}$	14	8 $\frac{5}{8}$	2485.05	17.256
3	6 $\frac{1}{2}$	11	1 $\frac{1}{2}$	1418.62	9.8518	4	8 $\frac{1}{2}$	14	9 $\frac{1}{2}$	2507.19	17.411
3	6 $\frac{3}{4}$	11	2 $\frac{1}{4}$	1435.36	9.9671	4	8 $\frac{3}{4}$	14	10 $\frac{1}{4}$	2529.42	17.565
3	7	11	3	1452.20	10.084	4	9	14	11	2551.76	17.720
3	7 $\frac{1}{4}$	11	3 $\frac{3}{8}$	1469.14	10.202	4	9 $\frac{1}{4}$	14	11 $\frac{3}{8}$	2574.19	17.876
3	7 $\frac{1}{2}$	11	4 $\frac{1}{8}$	1486.17	10.320	4	9 $\frac{1}{2}$	15	0 $\frac{3}{8}$	2596.72	18.033
3	7 $\frac{3}{4}$	11	5 $\frac{1}{8}$	1503.30	10.439	4	9 $\frac{3}{4}$	15	1 $\frac{3}{8}$	2619.35	18.189
3	8	11	6 $\frac{1}{4}$	1530.53	10.559	4	10	15	2 $\frac{1}{4}$	2642.08	18.347
3	8 $\frac{1}{4}$	11	7	1537.86	10.679	4	10 $\frac{1}{4}$	15	2 $\frac{7}{8}$	2664.91	18.506
3	8 $\frac{1}{2}$	11	7 $\frac{3}{4}$	1555.28	10.800	4	10 $\frac{1}{2}$	15	3 $\frac{1}{4}$	2687.83	18.665
3	8 $\frac{3}{4}$	11	8 $\frac{1}{2}$	1572.81	10.922	4	10 $\frac{3}{4}$	15	4 $\frac{1}{2}$	2710.85	18.825
3	9	11	9 $\frac{1}{4}$	1590.43	11.044	4	11	15	5 $\frac{1}{4}$	2733.97	18.965
3	9 $\frac{1}{4}$	11	10 $\frac{1}{8}$	1608.15	11.167	4	11 $\frac{1}{4}$	15	6 $\frac{1}{8}$	2757.19	19.147
3	9 $\frac{1}{2}$	11	10 $\frac{3}{8}$	1625.97	11.291	4	11 $\frac{1}{2}$	15	6 $\frac{3}{8}$	2780.51	19.309
3	9 $\frac{3}{4}$	11	11 $\frac{1}{4}$	1643.89	11.415	4	11 $\frac{3}{4}$	15	7 $\frac{1}{4}$	2803.92	19.471
3	10	12	0 $\frac{1}{2}$	1661.90	11.534	5	0	15	8 $\frac{1}{2}$	2827.44	19.635
3	10 $\frac{1}{4}$	12	1 $\frac{1}{4}$	1680.02	11.666	5	0 $\frac{1}{4}$	15	9 $\frac{1}{4}$	2851.05	19.798
3	10 $\frac{1}{2}$	12	2	1698.23	11.793	5	0 $\frac{1}{2}$	15	10	2874.76	19.963
3	10 $\frac{3}{4}$	12	2 $\frac{3}{4}$	1716.54	11.920	5	0 $\frac{3}{4}$	15	10 $\frac{3}{4}$	2898.56	20.128
3	11	12	3 $\frac{1}{4}$	1734.94	12.048	5	1	15	11 $\frac{1}{8}$	2922.47	20.294
3	11 $\frac{1}{4}$	12	4 $\frac{1}{4}$	1753.45	12.176	5	1 $\frac{1}{4}$	16	0 $\frac{3}{8}$	2946.47	20.461
3	11 $\frac{1}{2}$	12	5 $\frac{1}{4}$	1772.05	12.305	5	1 $\frac{1}{2}$	16	1 $\frac{1}{4}$	2970.57	20.629
3	11 $\frac{3}{4}$	12	6	1790.76	12.435	5	1 $\frac{3}{4}$	16	1 $\frac{3}{8}$	2994.77	20.797
4	0	12	6 $\frac{3}{4}$	1809.56	12.566	5	2	16	2 $\frac{3}{4}$	3019.07	20.965
4	0 $\frac{1}{4}$	12	7 $\frac{1}{2}$	1828.46	12.697	5	2 $\frac{1}{4}$	16	3 $\frac{1}{4}$	3043.47	21.135
4	0 $\frac{1}{2}$	12	8 $\frac{3}{4}$	1847.45	12.829	5	2 $\frac{1}{2}$	16	4 $\frac{1}{4}$	3067.96	21.305
4	0 $\frac{3}{4}$	12	9 $\frac{1}{4}$	1866.55	12.962	5	2 $\frac{3}{4}$	16	5 $\frac{1}{8}$	3092.56	21.476
4	1	12	9 $\frac{3}{4}$	1885.74	13.095	5	3	16	5 $\frac{3}{8}$	3117.25	21.647
4	1 $\frac{1}{4}$	12	10 $\frac{3}{8}$	1905.03	13.229	5	3 $\frac{1}{4}$	16	6 $\frac{1}{4}$	3142.04	21.819
4	1 $\frac{1}{2}$	12	11 $\frac{1}{2}$	1924.42	13.364	5	3 $\frac{1}{2}$	16	7 $\frac{1}{2}$	3166.92	21.992
4	1 $\frac{3}{4}$	13	0 $\frac{1}{4}$	1943.91	13.499	5	3 $\frac{3}{4}$	16	8 $\frac{1}{4}$	3191.91	22.166
4	2	13	1	1963.50	13.635	5	4	16	9	3216.99	22.333
4	2 $\frac{1}{4}$	13	1 $\frac{1}{8}$	1983.18	13.772	5	4 $\frac{1}{4}$	16	9 $\frac{3}{4}$	3242.17	22.515
4	2 $\frac{1}{2}$	13	2 $\frac{1}{8}$	2002.96	13.909	5	4 $\frac{1}{2}$	16	10 $\frac{5}{8}$	3267.46	22.621
4	2 $\frac{3}{4}$	13	3 $\frac{3}{8}$	2022.84	14.047	5	4 $\frac{3}{4}$	16	11 $\frac{3}{8}$	3292.83	22.866
4	3	13	4 $\frac{1}{4}$	2042.82	14.186	5	5	17	0 $\frac{1}{4}$	3318.31	23.043
4	3 $\frac{1}{4}$	13	5	2062.90	14.325	5	5 $\frac{1}{4}$	17	0 $\frac{3}{8}$	3343.88	23.221
4	3 $\frac{1}{2}$	13	5 $\frac{1}{4}$	2083.07	14.465	5	5 $\frac{1}{2}$	17	1 $\frac{1}{8}$	3369.56	23.330
4	3 $\frac{3}{4}$	13	6 $\frac{1}{2}$	2103.35	14.606	5	5 $\frac{3}{4}$	17	2 $\frac{1}{2}$	3395.33	23.578

Tables, Rules and Recipes.

Dia. in ft.	in.	Cir. in ft.	in.	Area in sq. inch.	Area in sq. ft.	Dia. in ft.	in.	Cir. in ft.	in.	Area in sq. inch.	Area in sq. ft.
5	6	17	3 $\frac{5}{8}$	3421.20	23.758	6	4	19	10 $\frac{3}{4}$	4536.47	31.503
5	6 $\frac{1}{4}$	17	4 $\frac{1}{8}$	3447.16	23.938	6	4 $\frac{1}{2}$	19	11 $\frac{1}{2}$	4566.36	31.710
5	6 $\frac{1}{2}$	17	4 $\frac{3}{8}$	3473.23	24.119	6	4 $\frac{1}{2}$	20	0 $\frac{1}{4}$	4596.35	31.919
6	6 $\frac{3}{4}$	17	5 $\frac{1}{8}$	3499.39	24.301	6	4 $\frac{3}{4}$	20	1 $\frac{1}{8}$	4626.44	32.114
5	7	17	6 $\frac{1}{2}$	3525.26	24.483	6	5	20	1 $\frac{1}{8}$	4656.63	32.337
5	7 $\frac{1}{4}$	17	7 $\frac{1}{4}$	3552.01	24.666	6	5 $\frac{1}{4}$	20	2 $\frac{5}{8}$	4686.92	32.548
5	7 $\frac{1}{2}$	17	8	3578.47	24.850	6	5 $\frac{1}{2}$	20	3 $\frac{1}{8}$	4717.30	32.759
5	7 $\frac{3}{4}$	17	8 $\frac{3}{4}$	3605.03	25.034	6	5 $\frac{3}{4}$	20	4 $\frac{1}{4}$	4747.79	32.970
5	8	17	9 $\frac{5}{8}$	3631.68	25.220	6	6	20	5	4778.37	33.183
5	8 $\frac{1}{4}$	17	10 $\frac{3}{8}$	3658.44	25.405	6	6 $\frac{1}{4}$	20	5 $\frac{3}{4}$	4809.05	33.396
5	8 $\frac{1}{2}$	17	11 $\frac{1}{8}$	3685.29	25.592	6	6 $\frac{1}{2}$	20	6 $\frac{1}{2}$	4839.83	33.619
5	8 $\frac{3}{4}$	17	11 $\frac{3}{8}$	3712.24	25.779	6	6 $\frac{3}{4}$	20	7 $\frac{3}{8}$	4870.70	33.824
5	9	18	0 $\frac{3}{4}$	3739.28	25.964	6	7	20	8 $\frac{1}{8}$	4901.68	34.039
5	9 $\frac{1}{4}$	18	1 $\frac{1}{2}$	3766.43	26.155	6	7 $\frac{1}{4}$	20	8 $\frac{7}{8}$	4932.75	34.255
5	9 $\frac{1}{2}$	18	2 $\frac{1}{4}$	3793.67	26.344	6	7 $\frac{1}{2}$	20	9 $\frac{3}{4}$	4963.92	34.471
5	9 $\frac{3}{4}$	18	3 $\frac{1}{8}$	3821.02	26.534	6	7 $\frac{3}{4}$	20	10 $\frac{1}{2}$	4995.19	34.688
5	10	18	3 $\frac{7}{8}$	3848.46	26.725	6	8	20	11 $\frac{1}{4}$	5026.26	34.906
5	10 $\frac{1}{4}$	18	4 $\frac{3}{8}$	3875.99	26.916	6	8 $\frac{1}{4}$	21	0 $\frac{1}{8}$	5058.02	35.125
5	10 $\frac{1}{2}$	18	5 $\frac{1}{2}$	3903.63	27.108	6	8 $\frac{1}{2}$	21	0 $\frac{7}{8}$	5089.58	35.344
5	10 $\frac{3}{4}$	18	6 $\frac{1}{4}$	3931.36	27.301	6	8 $\frac{3}{4}$	21	1 $\frac{5}{8}$	5121.24	35.564
5	11	18	7	3959.20	27.494	6	9	21	2 $\frac{3}{8}$	5153.00	35.784
5	11 $\frac{1}{4}$	18	7 $\frac{3}{4}$	3987.13	27.688	6	9 $\frac{1}{4}$	21	3 $\frac{1}{4}$	5184.86	36.006
5	11 $\frac{1}{2}$	18	8 $\frac{5}{8}$	4015.16	27.883	6	9 $\frac{1}{2}$	21	4	5216.82	36.227
5	11 $\frac{3}{4}$	18	9 $\frac{3}{8}$	4043.28	28.078	6	9 $\frac{3}{4}$	21	4 $\frac{3}{4}$	5248.87	36.450
6	0	18	10 $\frac{1}{8}$	4071.51	28.274	6	10	21	5 $\frac{1}{2}$	5281.02	36.674
6	0 $\frac{1}{4}$	18	10 $\frac{3}{8}$	4099.83	28.471	6	10 $\frac{1}{4}$	21	6 $\frac{3}{8}$	5313.27	36.897
6	0 $\frac{1}{2}$	18	11 $\frac{3}{4}$	4128.25	28.663	6	10 $\frac{1}{2}$	21	7 $\frac{1}{8}$	5345.62	37.122
6	0 $\frac{3}{4}$	19	0 $\frac{1}{2}$	4156.77	28.866	6	10 $\frac{3}{4}$	21	7 $\frac{7}{8}$	5378.07	37.347
6	1	19	1 $\frac{1}{4}$	4185.39	29.064	6	11	21	8 $\frac{3}{4}$	5410.62	37.573
6	1 $\frac{1}{4}$	19	2 $\frac{1}{8}$	4214.11	29.264	6	11 $\frac{1}{4}$	21	9 $\frac{1}{2}$	5443.26	37.700
6	1 $\frac{1}{2}$	19	2 $\frac{7}{8}$	4242.92	29.466	6	11 $\frac{1}{2}$	21	10 $\frac{1}{4}$	5476.00	38.027
6	1 $\frac{3}{4}$	19	3 $\frac{5}{8}$	4271.83	29.665	6	11 $\frac{3}{4}$	21	11	5508.84	38.256
6	2	19	4 $\frac{1}{2}$	4300.85	29.867						
6	2 $\frac{1}{4}$	19	5 $\frac{1}{4}$	4329.95	30.069						
6	2 $\frac{1}{2}$	19	6	4359.16	30.271						
6	2 $\frac{3}{4}$	19	6 $\frac{3}{4}$	4388.47	30.475						
6	3	19	7 $\frac{5}{8}$	4417.87	30.619						
6	3 $\frac{1}{4}$	19	8 $\frac{3}{8}$	4447.37	30.884						
6	3 $\frac{1}{2}$	19	9 $\frac{1}{4}$	4476.97	31.090						
6	3 $\frac{3}{4}$	19	9 $\frac{7}{8}$	4506.67	31.296						

Dia. in		Circum. in		Area in feet.	Dia. in		Circum. in		Area in feet.
ft.	in.	ft.	in.		ft.	in.	ft.	in.	
7	0	21	11 ⁷ / ₈	38.4846	11	0	34	6 ⁵ / ₈	95.0334
7	1	22	3	39.4060	11	1	34	9 ³ / ₄	96.4783
7	2	22	6 ¹ / ₈	40.3388	11	2	35	0 ⁷ / ₈	97.9347
7	3	22	9 ¹ / ₄	41.2825	11	3	35	4 ¹ / ₈	99.4021
7	4	23	0 ³ / ₈	42.2367	11	4	35	7 ¹ / ₄	100.8797
7	5	23	2 ¹ / ₈	43.2022	11	5	35	10 ⁵ / ₈	102.3689
7	6	23	6 ³ / ₄	44.1787	11	6	36	1 ¹ / ₂	103.8601
7	7	23	11	45.1656	11	7	36	4 ¹ / ₂	105.3794
7	8	24	1 ¹ / ₈	46.1638	11	8	36	7 ³ / ₄	106.9013
7	9	24	4 ¹ / ₈	47.1730	11	9	36	10 ⁷ / ₈	108.4342
7	10	24	7 ¹ / ₄	48.1926	11	10	37	2 ¹ / ₄	109.9772
7	11	24	10 ³ / ₈	49.2236	11	11	37	5 ¹ / ₄	111.5319
8	0	25	1 ¹ / ₂	50.2656	12	0	37	8 ³ / ₈	113.0976
8	1	25	4 ⁵ / ₈	51.6178	12	1	37	11 ¹ / ₂	114.6732
8	2	25	7 ⁷ / ₈	52.3816	12	2	38	2 ⁵ / ₈	116.2607
8	3	25	11	53.4562	12	3	38	5 ³ / ₄	117.8590
8	4	26	2 ¹ / ₈	54.5412	12	4	38	8 ⁷ / ₈	119.4674
8	5	26	5 ¹ / ₄	55.6377	12	5	39	0	121.0876
8	6	26	8 ³ / ₈	56.7451	12	6	39	3 ¹ / ₄	122.7187
8	7	26	11 ¹ / ₈	57.8628	12	7	39	6 ³ / ₈	124.3593
8	8	27	2 ³ / ₄	58.9920	12	8	39	9 ¹ / ₂	126.0127
8	9	27	5 ³ / ₄	60.1321	12	9	40	0 ⁵ / ₈	127.6765
8	10	27	9	61.2826	12	10	40	3 ³ / ₄	129.3504
8	11	28	0 ¹ / ₈	62.4445	12	11	40	6 ⁷ / ₈	131.0369
9	0	28	3 ¹ / ₄	63.6174	13	0	40	10	132.7326
9	1	28	6 ³ / ₈	64.8006	13	1	41	1 ¹ / ₈	134.4391
9	2	28	9 ¹ / ₂	65.9951	13	2	41	4 ³ / ₈	136.1574
9	3	29	0 ⁵ / ₈	67.2007	13	3	41	7 ¹ / ₂	137.8867
9	4	29	3 ³ / ₄	68.4166	13	4	41	10 ⁵ / ₈	139.6260
9	5	29	7	69.6440	13	5	42	1 ⁵ / ₈	141.3771
9	6	29	10 ¹ / ₈	70.8823	13	6	42	4 ⁷ / ₈	143.1391
9	7	30	1 ¹ / ₄	72.1309	13	7	42	8	144.9111
9	8	30	4 ³ / ₈	73.3910	13	8	42	11 ¹ / ₈	146.6949
9	9	30	7 ¹ / ₂	74.6620	13	9	43	2 ¹ / ₄	148.4896
9	10	30	11 ³ / ₈	75.9433	13	10	43	5 ¹ / ₂	150.2943
9	11	31	1 ³ / ₄	77.2362	13	11	43	8 ⁵ / ₈	152.1109
10	0	31	5	78.5400	14	0	43	11 ³ / ₄	153.9484
10	1	31	8 ¹ / ₈	79.8540	14	1	44	2 ⁷ / ₈	155.7758
10	2	31	11 ¹ / ₄	81.1795	14	2	44	6	157.6250
10	3	32	2 ³ / ₈	82.5190	14	3	44	9 ¹ / ₈	159.4852
10	4	32	5 ¹ / ₂	83.8627	14	4	45	0 ¹ / ₄	161.3553
10	5	32	8 ³ / ₈	85.2211	14	5	45	3 ¹ / ₂	163.2373
10	6	32	11 ³ / ₄	86.5903	14	6	45	6 ³ / ₈	165.1303
10	7	33	2 ⁷ / ₈	87.9697	14	7	45	9 ³ / ₄	167.0331
10	8	33	6 ¹ / ₈	80.3668	14	8	46	0 ⁷ / ₈	168.9479
10	9	33	9 ¹ / ₄	90.7627	14	9	46	4	170.8735
10	10	34	0 ³ / ₈	92.1749	14	10	46	7 ¹ / ₈	172.8091
10	11	34	3 ¹ / ₂	93.5986	14	11	46	11 ¹ / ₄	174.7565

Dia. in		Circum. in		Area in feet.	Dia. in		Circum. in		Area in feet.
ft.	in.	ft.	in.		ft.	in.	ft.	in.	
15	0	47	1½	176.7150	17	0	53	4¾	226.9806
15	1	47	4¾	178.6832	17	1	53	8	229.2105
15	2	47	7¾	180.6624	17	2	53	11⅛	231.4625
15	3	47	10⅞	182.6545	17	3	54	2¼	233.7055
15	4	48	2½	184.6555	17	4	54	5⅞	235.9682
15	5	48	5¼	186.6684	17	5	54	8½	238.2430
15	6	48	8¼	188.6923	17	6	54	11⅞	240.5287
15	7	48	11⅞	190.7260	17	7	55	2⅞	242.8241
15	8	49	2⅞	192.7716	17	8	55	6	245.1316
15	9	49	5¾	194.8282	17	9	55	9⅞	247.4500
15	10	49	8⅞	196.8946	17	10	56	0¼	249.7781
15	11	50	0	198.9730	17	11	56	3½	252.1184
16	0	50	3¼	201.0624	18	0	56	6½	254.4696
16	1	50	6¼	203.1615	18	1	56	9⅞	256.8303
16	2	50	9⅞	205.2726	18	2	57	0⅞	259.2033
16	3	51	0¼	207.3946	18	3	57	4	261.5872
16	4	51	3¾	209.5264	18	4	57	7⅞	263.9807
16	5	51	6½	211.6703	18	5	57	10¼	266.3864
16	6	51	10	213.8251	18	6	58	1⅞	268.8031
16	7	52	1⅞	215.9896	18	7	58	4½	271.2293
16	8	52	4¼	218.1662	18	8	58	7⅞	273.6678
16	9	52	7⅞	220.3537	18	9	58	10¾	276.1171
16	10	52	10½	222.5510	18	10	59	2	278.5761
16	11	53	1⅞	224.7603	18	11	59	5½	281.0472

Diam. Area.	Diam. Area.	Diam. Area.	Diam. Area.	Diam. Area.	Diam. Area.	Diam. Area.	Diam. Area.						
1 in.	7854	5 in.	19,635	9 in.	63,617	13 in.	132,732	17 in.	226,980	21 in.	346,361	25 in.	490,875
$\frac{1}{8}$.9940	$\frac{1}{8}$	20,629	$\frac{1}{8}$	65,396	$\frac{1}{8}$	135,297	$\frac{1}{8}$	229,330	$\frac{1}{8}$	350,497	$\frac{1}{8}$	495,796
$\frac{1}{4}$	1,2271	$\frac{1}{4}$	21,647	$\frac{1}{4}$	67,200	$\frac{1}{4}$	137,886	$\frac{1}{4}$	232,705	$\frac{1}{4}$	354,637	$\frac{1}{4}$	500,741
$\frac{3}{8}$	1,4848	$\frac{3}{8}$	22,690	$\frac{3}{8}$	69,029	$\frac{3}{8}$	140,500	$\frac{3}{8}$	237,104	$\frac{3}{8}$	358,841	$\frac{3}{8}$	505,711
$\frac{1}{2}$	1,7671	$\frac{1}{2}$	23,758	$\frac{1}{2}$	70,882	$\frac{1}{2}$	143,139	$\frac{1}{2}$	240,528	$\frac{1}{2}$	363,051	$\frac{1}{2}$	510,706
$\frac{5}{8}$	2,0739	$\frac{5}{8}$	24,850	$\frac{5}{8}$	72,759	$\frac{5}{8}$	145,802	$\frac{5}{8}$	243,977	$\frac{5}{8}$	367,284	$\frac{5}{8}$	515,725
$\frac{3}{4}$	2,4052	$\frac{3}{4}$	25,967	$\frac{3}{4}$	74,662	$\frac{3}{4}$	148,489	$\frac{3}{4}$	247,450	$\frac{3}{4}$	371,543	$\frac{3}{4}$	520,769
$\frac{7}{8}$	2,7611	$\frac{7}{8}$	27,108	$\frac{7}{8}$	76,588	$\frac{7}{8}$	151,201	$\frac{7}{8}$	250,947	$\frac{7}{8}$	375,826	$\frac{7}{8}$	525,837
2 in.	3,1416	6 in.	28,274	10 in.	78,540	14 in.	153,938	18 in.	254,409	22 in.	380,133	26 in.	530,930
$\frac{1}{8}$	3,5465	$\frac{1}{8}$	29,464	$\frac{1}{8}$	80,515	$\frac{1}{8}$	156,699	$\frac{1}{8}$	258,016	$\frac{1}{8}$	384,466	$\frac{1}{8}$	536,047
$\frac{1}{4}$	3,9760	$\frac{1}{4}$	30,679	$\frac{1}{4}$	82,516	$\frac{1}{4}$	159,485	$\frac{1}{4}$	261,587	$\frac{1}{4}$	388,822	$\frac{1}{4}$	541,189
$\frac{3}{8}$	4,4302	$\frac{3}{8}$	31,919	$\frac{3}{8}$	84,540	$\frac{3}{8}$	162,295	$\frac{3}{8}$	265,182	$\frac{3}{8}$	393,203	$\frac{3}{8}$	546,356
$\frac{1}{2}$	4,9087	$\frac{1}{2}$	33,183	$\frac{1}{2}$	86,590	$\frac{1}{2}$	165,130	$\frac{1}{2}$	268,803	$\frac{1}{2}$	397,608	$\frac{1}{2}$	551,547
$\frac{5}{8}$	5,4119	$\frac{5}{8}$	34,471	$\frac{5}{8}$	88,664	$\frac{5}{8}$	167,989	$\frac{5}{8}$	272,447	$\frac{5}{8}$	402,038	$\frac{5}{8}$	556,762
$\frac{3}{4}$	5,9395	$\frac{3}{4}$	35,784	$\frac{3}{4}$	90,762	$\frac{3}{4}$	170,873	$\frac{3}{4}$	276,117	$\frac{3}{4}$	406,493	$\frac{3}{4}$	562,002
$\frac{7}{8}$	6,4918	$\frac{7}{8}$	37,122	$\frac{7}{8}$	92,865	$\frac{7}{8}$	173,782	$\frac{7}{8}$	279,811	$\frac{7}{8}$	410,972	$\frac{7}{8}$	567,267
3 in.	7,0686	7 in.	38,484	11 in.	95,033	15 in.	176,715	19 in.	283,529	23 in.	415,476	27 in.	572,556
$\frac{1}{8}$	7,6699	$\frac{1}{8}$	39,871	$\frac{1}{8}$	97,205	$\frac{1}{8}$	179,672	$\frac{1}{8}$	287,272	$\frac{1}{8}$	420,004	$\frac{1}{8}$	577,870
$\frac{1}{4}$	8,2957	$\frac{1}{4}$	41,282	$\frac{1}{4}$	99,402	$\frac{1}{4}$	182,654	$\frac{1}{4}$	291,039	$\frac{1}{4}$	424,557	$\frac{1}{4}$	583,208
$\frac{3}{8}$	8,9462	$\frac{3}{8}$	42,718	$\frac{3}{8}$	101,623	$\frac{3}{8}$	185,661	$\frac{3}{8}$	294,831	$\frac{3}{8}$	429,135	$\frac{3}{8}$	588,571
$\frac{1}{2}$	9,6211	$\frac{1}{2}$	44,178	$\frac{1}{2}$	103,869	$\frac{1}{2}$	188,692	$\frac{1}{2}$	298,648	$\frac{1}{2}$	433,731	$\frac{1}{2}$	593,958
$\frac{5}{8}$	10,320	$\frac{5}{8}$	45,663	$\frac{5}{8}$	106,139	$\frac{5}{8}$	191,748	$\frac{5}{8}$	302,489	$\frac{5}{8}$	438,363	$\frac{5}{8}$	599,370
$\frac{3}{4}$	11,044	$\frac{3}{4}$	47,173	$\frac{3}{4}$	108,434	$\frac{3}{4}$	194,828	$\frac{3}{4}$	306,355	$\frac{3}{4}$	443,014	$\frac{3}{4}$	604,807
$\frac{7}{8}$	11,793	$\frac{7}{8}$	48,707	$\frac{7}{8}$	110,753	$\frac{7}{8}$	197,933	$\frac{7}{8}$	310,245	$\frac{7}{8}$	447,699	$\frac{7}{8}$	610,268
4 in.	12,566	8 in.	50,265	12 in.	113,097	16 in.	204,162	20 in.	314,160	24 in.	452,390	28 in.	615,753
$\frac{1}{8}$	13,364	$\frac{1}{8}$	51,848	$\frac{1}{8}$	115,466	$\frac{1}{8}$	209,216	$\frac{1}{8}$	318,099	$\frac{1}{8}$	457,115	$\frac{1}{8}$	621,263
$\frac{1}{4}$	14,186	$\frac{1}{4}$	53,456	$\frac{1}{4}$	117,859	$\frac{1}{4}$	207,394	$\frac{1}{4}$	322,063	$\frac{1}{4}$	461,864	$\frac{1}{4}$	626,798
$\frac{3}{8}$	15,033	$\frac{3}{8}$	55,088	$\frac{3}{8}$	120,276	$\frac{3}{8}$	210,597	$\frac{3}{8}$	326,051	$\frac{3}{8}$	466,638	$\frac{3}{8}$	632,357
$\frac{1}{2}$	15,904	$\frac{1}{2}$	56,745	$\frac{1}{2}$	122,718	$\frac{1}{2}$	213,825	$\frac{1}{2}$	330,064	$\frac{1}{2}$	471,436	$\frac{1}{2}$	637,941
$\frac{5}{8}$	16,800	$\frac{5}{8}$	58,426	$\frac{5}{8}$	125,184	$\frac{5}{8}$	217,077	$\frac{5}{8}$	333,401	$\frac{5}{8}$	476,259	$\frac{5}{8}$	643,594
$\frac{3}{4}$	17,729	$\frac{3}{4}$	60,132	$\frac{3}{4}$	127,676	$\frac{3}{4}$	220,353	$\frac{3}{4}$	338,163	$\frac{3}{4}$	481,106	$\frac{3}{4}$	649,122
$\frac{7}{8}$	18,665	$\frac{7}{8}$	61,882	$\frac{7}{8}$	130,192	$\frac{7}{8}$	223,654	$\frac{7}{8}$	342,250	$\frac{7}{8}$	485,978	$\frac{7}{8}$	654,839
29 in.	660,521	29 $\frac{1}{8}$	666,227	29 $\frac{1}{4}$	671,958	29 $\frac{3}{8}$	677,714	29 $\frac{1}{2}$	683,424	29 $\frac{3}{4}$	689,128	30 in.	706,860

USE OF THE TABLE: To find the capacity of any cylindrical measure, from 1 inch diameter to 30 inches, take the inside diameter of the measure in inches, and multiply the area in the table which corresponds to the diameter by the depth in inches, and divide the products, if gills are required, by 7.2135; if pints, by 23.875; if quarts, by 57.75; and if gallons, by 231. If bushels are required (say in a tierce or barrel, after the mean diameter is obtained), multiply as above, and divide the product by 2150.42; the quotient is the number of bushels. Calling the diameters feet the areas are feet,—then, if a ship's water tank, steam boiler, etc., is $\frac{5}{8}$, or any number of feet and parts of feet in diameter, find the area in the table which corresponds in inches, multiply it by the length in feet, and multiply this result by the number of gallons in a cubic foot (7.4805), and the product is the answer in gallons. In any case where there are more figures in the divisor than in the dividend, add ciphers.

CAPACITY OF CANS ONE INCH DEEP.

USE OF THE TABLE.

Required the contents of a vessel, diameter 6 7-10 inches, depth 10 inches.

By the table a vessel 1 inch deep and 6 7-10 inches diameter contains .15 (hundredths) gallon, then $15 \times 10 = 150$, or 1 gallon and 2 quarts.

Required the contents of a can, diameter 19 8-19 inches, depth 30 inches.

By the table a vessel 1 inch deep and 19 8-10 inches diameter contains 1 gallon and .33 (hundredths), then $1.33 \times 30 = 39.90$, or nearly 40 gallons.

Required the depth of a can whose diameter is 12 2-10 inches, to contain 16 gallons.

By the table a vessel 1 inch deep and 12 2-10 inches diameter contains .50 (hundredths) gallon, then $16 \div .50 = 32$ inches, the depth required.

Diam- eter.	$\frac{1}{10}$	$\frac{2}{10}$	$\frac{3}{10}$	$\frac{4}{10}$	$\frac{5}{10}$	$\frac{6}{10}$	$\frac{7}{10}$	$\frac{8}{10}$	$\frac{9}{10}$
3	.03	.03	.03	.03	.04	.04	.04	.04	.05
4	.05	.05	.05	.05	.06	.07	.07	.07	.08
5	.08	.08	.08	.09	.10	.10	.11	.11	.11
6	.12	.12	.12	.13	.13	.14	.14	.15	.16
7	.16	.17	.17	.18	.18	.19	.19	.20	.21
8	.21	.22	.22	.23	.23	.24	.25	.25	.26
9	.27	.28	.28	.29	.30	.30	.31	.31	.32
10	.34	.34	.35	.36	.36	.37	.38	.38	.39
11	.41	.41	.42	.43	.44	.44	.45	.46	.47
12	.48	.49	.50	.51	.52	.53	.53	.54	.55
13	.57	.58	.59	.60	.60	.61	.62	.63	.64
14	.66	.67	.68	.69	.70	.71	.72	.73	.74
15	.76	.77	.78	.79	.80	.81	.82	.83	.84
16	.87	.88	.89	.90	.91	.92	.93	.94	.95
17	.98	.99	1.005	1.017	1.028	1.040	1.051	1.063	1.075
18	1.101	1.113	1.125	1.138	1.150	1.162	1.170	1.187	1.200
19	1.227	1.240	1.253	1.266	1.279	1.292	1.304	1.317	1.330
20	1.360	1.373	1.385	1.400	1.414	1.428	1.441	1.455	1.478
21	1.499	1.513	1.527	1.542	1.556	1.570	1.585	1.600	1.612
22	1.645	1.660	1.675	1.696	1.705	1.720	1.735	1.750	1.770
23	1.798	1.814	1.830	1.845	1.861	1.876	1.892	1.908	1.923
24	1.958	1.974	1.991	2.007	2.023	2.040	2.056	2.072	2.096
25	2.125	2.142	2.159	2.176	2.193	2.210	2.227	2.244	2.261
26	2.298	2.316	2.333	2.351	2.369	2.386	2.404	2.422	2.440
27	2.478	2.496	2.515	2.533	2.552	2.570	2.588	2.607	2.625
28	2.665	2.684	2.703	2.722	2.741	2.764	2.780	2.800	2.820
29	2.859	2.879	2.898	2.918	2.938	2.958	2.977	2.997	3.017
30	3.060	3.080	3.100	3.121	3.141	3.162	3.182	3.202	3.223
31	3.267	3.288	3.309	3.330	3.351	3.372	3.393	3.414	3.436
32	3.481	3.503	3.524	3.543	3.568	3.590	3.612	3.633	3.655
33	3.702	3.725	3.747	3.773	3.795	3.814	3.837	3.860	3.882
34	3.930	3.953	3.976	4.003	4.022	4.046	4.070	4.092	4.115
35	4.165	4.188	4.212	4.236	4.260	4.284	4.307	4.331	4.355
36	4.406	4.430	4.455	4.483	4.503	4.528	4.553	4.577	4.602
37	4.654	4.679	4.704	4.730	4.755	4.780	4.805	4.834	4.855
38	4.909	4.935	4.961	4.987	5.012	5.038	5.064	5.090	5.120
39	5.171	5.197	5.224	5.250	5.277	5.304	5.330	5.357	5.383
40	5.440	5.467	5.491	5.521	5.548	5.576	5.603	5.630	5.684

RULES FOR CALCULATING CIRCUMFERENCES.

1st. Multiply the given diameter by 22, and divide the product by 7; or 2d, divide 22 by 7 and multiply the diameter by the quotient; or 3d, multiply the diameter by 3.1416; or 4th, multiply the diameter by 3 and add 1 inch for every 7 of the diameter, or about $\frac{1}{8}$ inch for every 1. For example: If the given diameter be 15 inches, by the first rule the circumference would be 47 1-7 inches; by the second, 47 1-7 inches; by the third, 47.1240 inches; by the fourth, 47 $\frac{1}{8}$ inches; by the table, 47 $\frac{1}{8}$ inches. It will be seen that the result is not just the same by the several rules, yet either is near enough for general use and practice.

WEIGHT OF WATER.

1	cubic inch.....	is equal to	.03617	pound.
12	cubic inches.....	is equal to	.434	pound.
1	cubic foot.....	is equal to	62.5	pounds.
1	cubic foot.....	is equal to	7.50	U. S. gallons.
1.8	cubic feet.....	is equal to	112.00	pounds.
35.84	cubic feet.....	is equal to	2240.00	pounds.
1	cylindrical inch.....	is equal to	.02842	pound.
12	cylindrical inches.....	is equal to	.341	pound.
1	cylindrical foot.....	is equal to	49.10	pounds.
1	cylindrical foot.....	is equal to	6.00	U. S. gallons.
2.282	cylindrical feet.....	is equal to	112.00	pounds.
45.64	cylindrical feet.....	is equal to	2240.00	pounds.
13.43	United States gallons...	is equal to	112.00	pounds.
268.8	United States gallons...	is equal to	2240.00	pounds.

Center of pressure is at two-thirds depth from surface.

TO FIND NUMBER OF BARRELS IN CISTERNS.

The following table shows the number of barrels (31 $\frac{1}{2}$ gallons) contained in cisterns of various diameters, from 5 to 30 feet, and of depths ranging from 5 to 20 feet.

To use the table, find the required depth in the side column, and then follow along the line to the column which has the required diameter at the top. Thus, with a cistern 6 feet deep and 16 feet in diameter, we find 6 in the second line, and then follow along until column 16 is reached, when we find that the contents is 286.5 barrels.

NUMBER OF BARRELS ($31\frac{1}{2}$ GALLONS) IN CISTERNS AND TANKS.

Depth in feet.	Diameter in feet.								
	5	6	7	8	9	10	11	12	13
5	23.3	33.6	45.7	59.7	75.5	93.2	112.8	134.3	157.6
6	28.0	40.3	54.8	71.7	90.6	111.9	135.4	161.1	189.1
7	32.7	47.0	64.0	83.6	105.7	130.6	158.0	188.0	220.6
8	37.3	53.7	73.1	95.5	120.9	149.2	180.5	214.8	252.1
9	42.0	60.4	82.2	107.4	136.0	167.9	203.1	241.7	283.7
10	46.7	67.1	91.4	119.4	151.1	186.5	225.7	268.6	315.2
11	51.3	73.9	100.5	131.3	166.2	205.1	248.2	295.4	346.7
12	56.0	80.6	109.7	143.2	181.3	223.8	270.8	322.3	378.2
13	60.7	87.3	118.8	155.2	196.4	242.4	293.4	349.1	409.7
14	65.3	94.0	127.9	167.1	211.5	261.1	315.9	376.0	441.3
15	70.0	100.7	137.1	179.0	226.6	289.8	338.5	402.8	472.8
16	74.7	107.4	146.2	191.0	241.7	298.4	361.1	429.7	504.3
17	79.3	114.1	155.4	202.9	256.8	317.0	383.6	456.6	535.8
18	84.0	120.9	164.5	214.8	272.0	335.7	406.2	483.4	567.3
19	88.7	127.6	173.6	226.8	287.0	354.3	428.8	510.3	598.0
20	93.3	134.3	182.8	238.7	302.1	373.0	451.3	537.1	630.4

Depth in feet.	Diameter in feet.								
	14	15	16	17	18	19	20	21	22
5	182.8	209.8	238.7	269.5	302.1	336.6	373.0	411.2	451.3
6	219.3	251.8	286.5	323.4	362.6	404.0	447.6	493.5	541.6
7	255.9	293.7	334.2	377.3	423.0	471.3	522.2	575.7	631.9
8	292.4	335.7	382.0	431.2	483.4	538.6	596.8	658.0	722.1
9	329.0	377.7	429.7	485.1	543.8	605.9	671.4	740.2	812.4
10	365.5	419.6	477.4	539.0	604.3	673.3	746.0	822.5	902.7
11	402.1	461.6	525.2	592.9	667.7	740.6	820.6	904.7	992.9
12	438.6	503.5	572.9	646.8	725.1	807.9	895.2	987.0	1083.2
13	475.2	545.5	620.7	700.7	785.5	875.2	969.8	1069.2	1173.5
14	511.8	587.5	668.2	754.6	846.6	942.6	1044.4	1151.5	1263.7
15	548.3	629.4	716.2	808.5	906.9	1009.9	1119.0	1233.7	1354.0
16	584.9	671.4	773.9	862.4	966.8	1077.2	1193.6	1315.9	1444.3
17	621.4	713.4	811.6	916.3	1027.2	1144.6	1268.2	1398.2	1534.5
18	658.0	755.3	859.4	970.2	1087.7	1211.9	1342.8	1480.4	1624.8
19	694.5	797.3	907.1	1024.1	1148.1	1279.2	1417.4	1562.7	1715.1
20	731.1	839.3	954.9	1078.0	1208.5	1346.5	1492.0	1644.9	1805.3

Depth in feet.	Diameter in feet.								
	23	24	25	26	27	28	29	30	
5	493.3	537.1	582.8	630.4	679.8	731.1	784.2	839.3	
6	592.0	644.5	699.4	756.5	815.8	877.3	941.1	1007.1	
7	690.6	752.0	815.9	882.5	951.7	1023.5	1097.9	1175.0	
8	789.3	859.4	932.5	1008.6	1087.7	1169.7	1254.8	1342.8	
9	887.9	966.8	1049.1	1134.7	1223.6	1316.0	1411.6	1510.7	
10	986.6	1074.2	1165.6	1260.8	1359.6	1462.2	1568.2	1678.5	
11	1085.2	1181.7	1282.2	1386.8	1495.6	1608.7	1723.0	1846.4	
12	1183.9	1289.1	1398.7	1512.9	1631.5	1754.6	1882.2	2014.2	
13	1282.6	1396.5	1515.3	1639.0	1767.5	1900.8	2039.0	2182.0	
14	1381.2	1503.9	1631.9	1765.1	1903.4	2047.1	2195.9	2343.9	
15	1479.9	1611.4	1748.4	1891.1	2039.4	2193.3	2352.7	2517.8	
16	1578.5	1718.8	1865.0	2017.2	2175.4	2339.5	2509.6	2685.6	
17	1677.2	1826.2	1981.6	2143.3	2311.3	2485.7	2666.4	2853.5	
18	1775.9	1933.6	2098.1	2269.4	2447.3	2631.9	2823.3	3021.3	
19	1874.5	2041.1	2214.7	2395.4	2583.2	2778.1	2980.1	3189.2	
20	1973.2	2148.5	2321.2	2521.5	2719.2	2924.4	3137.0	3357.0	

For tanks that are tapering the diameter may be measured four-tenths from large end.

TABLE SHOWING THE PRESSURE OF WATER PER SQUARE INCH, DUE TO DIFFERENT HEADS, FROM 1 TO 250 FEET.

Head.	Pressure in lbs.	Head.	Pressure in lbs.	Head.	Pressure in lbs.
1	.4335	19	8.237	37	16.04
2	.8670	20	8.670	38	16.47
3	1.300	21	9.104	39	16.91
4	1.734	22	9.537	40	17.34
5	2.167	23	9.971	50	21.67
6	2.601	24	10.40	100	43.35
7	3.035	25	10.84	110	47.68
8	3.468	26	11.27	120	52.02
9	3.902	27	11.70	130	56.36
10	4.335	28	12.14	140	60.69
11	4.768	29	12.57	150	65.03
12	5.202	30	13.00	160	69.36
13	5.636	31	13.44	170	73.70
14	6.069	32	13.87	180	78.03
15	6.503	33	14.31	190	82.36
16	6.936	34	14.74	200	86.70
17	7.370	35	15.17	225	97.41
18	7.803	36	15.60	250	108.37

MEASURES OF CAPACITY AND WEIGHT.

MEASURES OF WEIGHT.—AVOIRDUPOIS.—16 drams equal 1 ounce; 16 ounces 1 pound; 112 pounds 1 hundredweight; 20 hundredweights 1 ton. TROY.—24 grains 1 pennyweight; 20 pennyweights 1 ounce; 12 ounces 1 pound. APOTHECARIES'.—20 grains equal 1 scruple; 3 scruples 1 dram; 8 drams 1 ounce; 12 ounces 1 pound.

MEASURES OF CAPACITY (DRY).—2150.42 cubic inches equal 1 United States (or Winchester) bushel; the dimensions of which are $18\frac{1}{2}$ inches diameter inside, $19\frac{1}{2}$ inches outside and 8 inches deep; 2747.70 cubic inches equal 1 heaped bushel, the cone of which must not be less than 6 inches high.

MEASURES OF CAPACITY (LIQUIDS).—231 cubic inches equal 1 United States standard gallon; 277.274 cubic inches equal 1 Imperial (British) gallon; $31\frac{1}{2}$ United States gallons equal 1 barrel; 42 gallons equal 1 tierce; 63 gallons equal 1 hogshead; 84 gallons equal 1 puncheon; 126 gallons equal 1 pipe; 252 gallons equal 1 tun.

FRENCH MEASURES OF FREQUENT REFERENCE, COMPARED WITH U. S. MEASURES.—Meter, 3.28 feet; Decimeter (1-10 meter), 3.94 inches; Centimeter, .4 inch; Millimeter, .04 inch; Hectoliter, 26.42 gallons; Liter, 2.11 pints; Kilogram, 2.2 pounds.

WEIGHTS OF VARIOUS SUBSTANCES.—POUNDS AVOIR-
DUPOIS.—1 cubic foot of bricks weighs 124 pounds; 1 do. of sand or loose earth, 95; 1 do. of cork, 15; 1 do. of granite, 170; 1 do. of cast iron, 450; 1 do. of wrought iron, 485; 1 do. of steel, 490; 1 do. of copper, 555; 1 do. lead, 709; 1 do. brass, 520; 1 do. tin, 459; 1 do. white pine, 30; 1 do. oak, 48; 1 do. sea water, 64.08; 1 do. fresh, 62.35; 1 do. air, 0765.

SIZES OF TIN WARE IN THE FORM OF FRUSTUM OF A CONE.

PANS.

Size.	Diam. of top.	Diam. of bot.	Hight.	Size.	Diam. of top.	Diam. of bot.	Hight.
20 qt.	19½ in.	13 in.	8 in.	2 qt.	9 in.	6 in.	3¾ in.
16 "	18 "	11¼ "	6¼ "	3 pt.	8¼ "	5¾ "	2¾ "
14 "	15¼ "	9¼ "	6¼ "	1 "	6¼ "	4 "	2¾ "
10 "	14¾ "	11 "	4⅞ "	Pie	9 "	7½ "	1¾ "
6 "	12¾ "	9 "	4 "				

DISH KETTLES AND PAILS.

Size.	Diam. of top.	Diam. of bot.	Hight.	Size.	Diam. of top.	Diam. of bot.	Hight.
1½ qt.	13 in.	9 in.	9 in.	6 qt.	9¼ in.	5½ in.	6½ in.
10 "	11½ "	7 "	8 "	2 "	6¼ "	4 "	4 "

COFFEE POTS.

Size.	Diam. of top.	Diam. of bot.	Hight.	Size.	Diam. of top.	Diam. of bot.	Hight.
1 gal.	4 in.	7 in.	8½ in.	3 qt.	3½ in.	6 in.	8½ in.

WASH BOWLS.

Size	Diam. of top.	Diam. of bot.	Hight.
Large wash bowl.....	11 in.	5¾ in.	5 in.
Cullender	11 "	5¾ "	5 "
Small wash bowl.....	9½ "	5½ "	3¾ "
Milk strainer.....	9½ "	5½ "	3¾ "

DIPPERS.

Size.	Diam. of top.	Diam. of bot.	Hight.	Size.	Diam. of top.	Diam. of bot.	Hight.
½ gal.	6½ in.	4 in.	4 in.	1 pt.	4¼ in.	3¾ in.	2¾ in.

MEASURES.

Size.	Diam. of top.	Diam. of bot.	Hight.	Size.	Diam. of top.	Diam. of bot.	Hight.
1 gal.	5½ in.	6¼ in.	9¼ in.	1 pt.	2¼ in.	3¼ in.	4¼ in.
½ "	4 "	4⅞ "	8 "	½ "	2⅜ "	2⅞ "	3⅞ "
1 qt.	3½ "	4 "	5¾ "				

DRUGGISTS' AND LIQUOR DEALERS' MEASURES.

Size.	Diam. of top.	Diam. of bot.	Hight.	Size.	Diam. of top.	Diam. of bot.	Hight.
5 gal.	8 in.	13½ in.	12⅝ in.	½ gal.	3¼ in.	6⅝ in.	6 in.
3 "	7 "	11½ "	10¼ "	1 qt.	2½ "	5⅝ "	4⅞ "
2 "	6 "	10½ "	8⅝ "	1 pt.	2 "	4 "	4 "
1 "	3¾ "	8¾ "	7½ "	½ "	1¾ "	3¾ "	3⅞ "

TABLE OF EFFECTS UPON BODIES BY HEAT.

	Degrees F.
Cast iron thoroughly melts at.....	2,228
Gold melts at.....	1,913
Silver melts at.....	1,723
Copper melts at.....	1,929
Brass melts at.....	1,873
Zinc melts at.....	779
Lead melts at.....	618
Bismuth melts at.....	506
Tin melts at.....	444
Tin and lead, equal parts, melt at.....	418
Tin 2 parts, bismuth 5 and lead 3, melt at.....	199

PRACTICAL RECEIPTS.
SOLDERS.**SOLDER FOR GOLD.**

Gold, 6 pennyweights; silver, 1 pennyweight; copper, 2 pennyweights.

SOLDER FOR SILVER, FOR THE USE OF JEWELERS.

Fine silver, 19 pennyweights; copper, 1 pennyweight; sheet brass, 10 pennyweights.

WHITE SOLDER FOR SILVER.

Silver, 1 ounce; tin, 1 ounce.

WHITE SOLDER FOR RAISED BRITANNIA WARE.

Tin, 100 pounds; copper, 3 ounces; to make it free, add lead, 3 ounces.

BEST SOFT SOLDER FOR CAST BRITANNIA WARE.

Tin, 8 pounds; lead, 5 pounds.

YELLOW SOLDER FOR BRASS OR COPPER.

Copper, 1 pound; zinc, 1 pound.

YELLOW SOLDER FOR BRASS OR COPPER.

(Stronger than the last.) Copper, 32 pounds; zinc, 29 pounds; tin, 1 pound.

SOLDER FOR COPPER.

Copper, 10 pounds; zinc, 9 pounds.

BLACK SOLDER.

Copper, 2 pounds; zinc, 3 pounds; tin, 2 ounces.

BLACK SOLDER.

Sheet brass, 20 pounds; tin, 6 pounds; zinc, 1 pound.

SILVER SOLDER FOR PLATED METAL.

Fine silver, 1 ounce; brass, 10 pennyweights.

PLUMBERS' SOLDER.

Lead, 2; tin, 1 part.

TINMEN'S SOLDER.

Lead, 1; tin, 1 part.

PEWTERERS' SOLDER.

Tin, 2; lead, 1 part.

HARD SOLDER.

Copper, 2; zinc, 1 part.

SOLDER FOR STEEL JOINTS.

Silver, 19 pennyweights; copper, 1 pennyweight; brass, 2 pennyweights. Melt under a coat of charcoal dust.

SOFT GOLD SOLDER

Is composed of 4 parts gold, 1 of silver and 1 of copper. It can be made softer by adding brass, but the solder becomes more liable to oxidize,

CEMENT FOR MENDING EARTHEN AND GLASS WARE.

1. Heat the article to be mended a little above boiling water heat, then apply a thin coating of gum shellac on both surfaces of the broken vessel, and when cold it will be as strong as it was originally. 2. Dissolve gum shellac in alcohol, apply the solution and bind the parts firmly together until the cement is perfectly dry.

CEMENT FOR STONE WARE.

Another cement in which an analogous substance, the curd of milk, is employed, is made by boiling slices of skim milk cheese into a gluey consistence in a great quantity of water, and then incorporating it with quicklime on a slab with a muller, or in a marble mortar. When this compound is applied warm to broken edges of stone ware, it unites them very firmly after it is cold.

IRON RUST CEMENT

Is made from 50 to 100 parts of iron borings, pounded and sifted, mixed with 1 part of sal ammoniac, and when it is to be applied, moistened with as much water as will give it a pasty consistency. Another composition of the same kind is made by mixing 4 parts of fine borings or filings of iron, 2 parts of potters' clay and 1 part of pounded potsherds, and making them into a paste with salt and water.

CEMENT FOR IRON TUBES, BOILERS, ETC.

Finely powdered iron, 66 parts; sal ammoniac, 1 part; water, a sufficient quantity to form a paste.

CEMENT FOR IVORY, MOTHER OF PEARL, ETC.

Dissolve 1 part of isinglass and 2 of white glue in 30 of water, strain and evaporate to 6 parts. Add 1-30 part

of gum mastic, dissolve in $\frac{1}{2}$ part of alcohol and 1 part of white zinc. When required for use warm and shake up.

CEMENT FOR HOLES IN CASTINGS.

The best cement for this purpose is made by mixing 1 part of sulphur in powder, 2 parts of sal ammoniac and 80 parts of clean powdered iron turnings. Sufficient water must be added to make it into a thick paste, which should be pressed into the holes or seams which are to be filled up. The ingredients composing this cement should be kept separate and not mixed until required for use. It is to be applied cold, and the casting should not be used for two or three days afterward.

CEMENT FOR COPPERSMITHS AND ENGINEERS.

Boiled linseed oil and red lead mixed together into a putty is often used by coppersmiths and engineers to secure joints. The washers of leather or cloth are smeared with this mixture in a pasty state.

A CHEAP CEMENT.

Melted brimstone, either alone or mixed with rosin and brick dust, forms a tolerably good and very cheap cement.

PLUMBERS' CEMENT

Consists of black rosin, 1 part; brick dust, 2 parts; well incorporated by a melting heat.

CEMENT FOR BOTTLE CORKS.

The bituminous or black cement for bottle corks consists of pitch hardened by the addition of rosin and brick dust.

CHINA CEMENT.

Take the curd of milk, dried and powdered, 10 ounces ; quicklime, 1 ounce ; camphor, 2 drams. Mix and keep in closely stopped bottles. When used, a portion is to be mixed with a little water into a paste, to be applied quickly.

CEMENT FOR LEATHER.

A mixture of India rubber and shellac varnish makes a very adhesive leather cement. A strong solution of common isinglass, with a little diluted alcohol added to it, makes an excellent cement for leather.

MARBLE CEMENT.

Take plaster of paris and soak it in a saturated solution of alum, then bake the two in an oven, the same as gypsum is baked to make it plaster of paris ; after which they are ground to powder. It is then used as wanted, being mixed up with water like plaster and applied. It sets into a very hard composition capable of taking a very high polish. It may be mixed with various coloring minerals to produce a cement of any color capable of imitating marble.

CEMENT FOR MARBLE WORKERS AND COPPERSMITHS.

White of an egg alone, or mixed with finely sifted quicklime, will answer for uniting objects which are not exposed to moisture. The latter combination is very strong and is much employed for joining pieces of spar and marble ornaments. A similar composition is used by coppersmiths to secure the edges and rivets of boilers, only bullock's blood is the albuminous matter used instead of white of egg.

TRANSPARENT CEMENT FOR GLASS.

Dissolve 1 part of india rubber in 64 of chloroform, then add gum mastic in powder 14 to 24 parts, and digest for two days with frequent shaking. Apply with camel's hair brush.

CEMENT TO MEND IRON POTS AND PANS.

Take 2 parts of sulphur, and 1 part, by weight, of fine black lead; put the sulphur in an old iron pan, holding it over the fire until it begins to melt, then add the lead, stir well until all is mixed and melted, then pour out on an iron plate or smooth stone. When cool, break into small pieces. A sufficient quantity of this compound being placed upon the crack of the iron pot to be mended, can be soldered by a hot iron in the same way a tinsmith solders his sheets. If there is a small hole in the pot, drive a copper rivet in it and then solder over it with this cement.

CEMENT TO RENDER CISTERNS AND CASKS WATER TIGHT.

An excellent cement for resisting moisture is made by incorporating thoroughly 8 parts of melted glue, of the consistence used by carpenters, with 4 parts of linseed oil, boiled into varnish with litharge. This cement hardens in about 48 hours and renders the joints of wooden cisterns and casks air and water tight. A compound of glue with one-quarter its weight of Venice turpentine, made as above, serves to cement glass, metal and wood to one another. Fresh made cheese curd and old skim milk cheese, boiled in water to a slimy consistency, dissolved in a solution of bicarbonate of potash are said to form a good cement for glass and porcelain. The gluten of

wheat, well prepared, is also a good cement. White of eggs with flour and water, well mixed, and smeared over linen cloth, forms a ready lute for steam joints in small apparatus.

A GOOD CEMENT.

Shellac, dissolved in alcohol or in a solution of borax, forms a pretty good cement.

CEMENT FOR REPAIRING FRACTURED BODIES OF ALL KINDS.

White lead ground upon a slab with linseed oil varnish and kept out of contact of air affords a cement capable of repairing fractured bodies of all kinds. It requires a few weeks to harden. When stone and iron are to be cemented together, a compound of equal parts of sulphur with pitch answers very well.

CEMENT FOR CRACKS IN WOOD.

Make a paste of slaked lime 1 part, rye meal 2 parts, with a sufficient quantity of linseed oil. Or dissolve 1 part of glue in 16 parts of water, when almost cool stir in sawdust and prepared chalk a sufficient quantity. Or oil varnish thickened with a mixture of equal parts of white lead, red lead, litharge and chalk.

CEMENT FOR JOINING METALS AND WOOD.

Melt rosin and stir in calcined plaster until reduced to a paste, to which add boiled oil a sufficient quantity to bring it to the consistence of honey; apply warm. Or, melt rosin 180 parts and stir in burnt umber 30, calcined plaster 15 and boiled oil 8 parts.

GAS FITTERS' CEMENT.

Mix together resin $4\frac{1}{2}$ parts, wax 1 part, and Venetian red 3 parts.

IMPERVIOUS CEMENT FOR APPARATUS, CORKS, ETC.

Zinc white rubbed up with copal varnish to fill up the indentures; when dry, to be covered with the same mass somewhat thinner, and lastly with copal varnish alone.

CEMENT FOR FASTENING BRASS TO GLASS VESSELS.

Melt rosin 150 parts, wax 30, and add burnt ocher 30 and calcined plaster 2 parts. Apply warm.

CEMENT FOR FASTENING BLADES, FILES, ETC.

Shellac 2 parts, prepared chalk 1, powdered and mixed. The opening for the blade is filled with this powder, the lower end of the iron heated and pressed in.

HYDRAULIC CEMENT PAINT.

If hydraulic cement be mixed with oil, it forms a first rate anti-combustible and excellent water proof paint for roofs of buildings, outhouses, walls, &c.

TO STOP A LEAKY ROOF.

Twenty-five pounds yellow ocher, 1 pound litharge, 6 pounds black lead, 1 pound fine salt; boil well in oil. Soak strips of cloth in the above and paste over the seams. Good where solder is not practicable.

FLUX FOR SOLDERING TIN ROOF.

One part rosin and 2 parts binnacle oil mixed hot and used the same as rosin alone; or, cut with alcohol 1 pint as much rosin as possible and put on with a swab. Either good when the wind blows. Or saponified or red oil used with a swab along the seams. Solder flows more freely than with rosin alone.

SOLDERING FLUID OR FLUX.

Prussiate of potash, borax and copperas, each 1 dram; sal ammoniac $\frac{1}{2}$ ounce, muriatic acid $3\frac{1}{2}$ ounces, well mixed, then add as much zinc as it will dissolve. Add 1 pint or more water according to strength required.

ANOTHER.

Sal ammoniac and borax, each 1 dram; chloride of zinc 1 ounce, water 1 pint. It will not eat copper or tarnish tin. Use less water and it will be stronger.

THE NEW METAL WORKER PATTERN BOOK.

A Treatise on Pattern Cutting as Applied
to all Branches of Sheet Metal Work.

By GEORGE W. KITTREDGE.

430 Pages; 744 Illustrations; Size, 10 x 13
Inches, Cloth Bound, Price, - - \$5.00.



This is the Most Elaborate and Complete Work that has ever
been brought out for the use of Sheet Metal Pattern Cutters.

It is printed from new type with a new and improved arrangement,
especially convenient for reference and study.

Parts of the former treatise, entitled The Metal Worker Pattern Book,
have been utilized in the preparation of this

GREATLY ENLARGED AND IMPROVED WORK,

but these have been REWRITTEN AND SIMPLIFIED, and later methods em-
bodied which have come into use since the publication of the original work.

218 Problems are now given,
75 of which are entirely new.  

Apprentices and Students will find the entire subject presented in such
a manner as will facilitate systematic study.

Tinners and Cornice Makers will here find elucidated every problem of
ordinary occurrence, from the simplest to the most complex.

Triangulation is here for the first time treated systematically and in a
way to meet the practical needs of the trade.

The opening chapters are devoted to the preliminary information neces-
sary to give the student a thorough understanding of the subject, treating
the topics fully and with appropriate illustrations. The work is comprised
in the following chapters:

- I. Terms and Definitions—15 Pages,
- II. Drawing Instruments and Materials—13 Pages,
- III. Linear Drawing—6 Pages,
- IV. Geometrical Problems—35 Pages,
- V. PRINCIPLES OF PATTERN CUTTING—25 Pages,
- VI. PATTERN PROBLEMS (3 Sections)—325 Pages.
 1. Miter Cutting,
 2. Flaring Work,
 3. Triangulation.

This work in its perfected form is a complete

Encyclopedia of Pattern Problems

for Tinners, Cornice Makers and Sheet Metal Workers.

DAVID WILLIAMS COMPANY, Publishers,
232-238 William St., - - - - New York.

Furnace Heating.

A Practical and Comprehensive Treatise on Warming Buildings with Hot Air. By WILLIAM G. SNOW. With an Appendix on Furnace Fittings. 170 pages, 6 x 9 inches. Cloth bound ----- \$1.50

This is the only book that has been brought out which presents a systematic and reliable treatment of the warm air furnace system of heating. It deals with the various types of furnaces, their construction, proper location and setting, together with furnace fittings, and all matters pertaining to the installation of furnaces and to effective and economical heating by warm air. It is recommended to practical furnace men, to architects, builders and house owners, and to tanners and plumbers in suburban sections who do furnace work.

Partial Summary of Contents by Chapters.

Chapter I.—Furnaces—Is devoted to Furnace Construction—The Relative Proportion of Furnace Parts—Secondary Heating Surface—Economy and Efficiency—Heating Capacity and Exposed Wall Surface—Manufacturers' Ratings of Their Own Productions, etc.

Chapter II.—House Heating—Compares Furnaces and other Apparatus, and describes Method of Setting Brick and Portable Furnaces—Location and Area of Cold Air Supply—Cold Air Rooms and Air Filters—Return Ducts and Air Circulation—Size of Hot Air Pipes—Location of Registers, etc.

Chapter III.—The Combination System—Discusses Heating Distant Rooms with Radiators—Balancing the System—Location of Water Heater in Furnace—Capacity of Water Heaters—Size of Radiators, etc.

Chapter IV.—Air—Deals with the Necessity of Ventilation—Water Needed to Moisten Air—Expansion of Air—Velocity of Air in Tubes, etc.

Chapter V.—Heating and Ventilation of Buildings—Considers the Size of Furnaces Required—Fresh Air Room and Supply—Air Circulation—Size of Flues—Use of Stack Heaters—Size of Heating Coils in Vent Flues, etc.

Chapter VI.—Heating of Public Buildings, Churches and Stores—Is given to the Size of Furnaces Required—Grate Surface in Ventilated Buildings—Air Supply—Size of Heating and Ventilating Flues—Size of Stack Heater, etc.

Chapter VII.—Fan-Furnace Combination System—Is devoted to Positive Warm Currents from Fan Systems—Location of Fan and Driving Apparatus—How Good Furnaces are Aided by Fans—Types and Efficiency of Fans—Area of Ducts and Flues, etc.

Chapter VIII.—Temperature Control.

Chapter IX.—Estimate and Contract Blanks.

Chapter X.—Value of Fuels—The Proper Size for Furnace Chimneys—with tables.

APPENDIX.

Furnace Fittings.—A section of 45 pages dealing with the Making of Furnace Casings—Metal Cold Air Boxes—Making Furnace Bonnets and Collars—Making Pipe and Elbows—Register Boxes and Stack Shoes, etc.

David Williams Company, Publishers,
232-238 William Street, New York.

Kitchen Boiler Connections

A Selection of Practical Letters and Articles
Relating to Water Backs and Range Boilers.

FIFTH EDITION, ENLARGED.

113 Illustrations; 195 Pages; 6 x 9 in.; Cloth, \$1.00

The Plumbing and Letter Box departments of *The Metal Worker* have contained many articles on the work of setting range boilers and overcoming the difficulties commonly encountered. The extensive correspondence that the discussion of these topics has called forth indicates the widespread interest that they attracted, and the letters, coming from all parts of the country and from practical men who have written from their personal experience, constitute a most valuable source of information. The descriptions are plain and the illustrations add all that is required to make them clear and comprehensive.

These articles have been carefully edited, and are now embodied in a book, which is divided into two parts, the first on water backs and boilers and their connections, and the second on heating rooms from range boilers.

The main divisions of the volume areas follows: Water Backs and Their Construction; Boiler Construction, Operation, and Connections; Circulating Pipes; Multiple Connections; Double Boilers; Difficulties Met in Every-day Practice; Relief Pipe and Vacuum Valve; Horizontal Boilers; Miscellaneous; Lime Deposits in Water Backs and Boilers; Heating Room from Kitchen Boiler; Radiators Heated from Coils in Stoves.

DAVID WILLIAMS COMPANY, Publishers,
232-238 WILLIAM STREET, NEW YORK.

Steam and Hot-Water Fitters' Text-Book.

Prepared for the Steam and Hot-Water Heating Course at the New York Trade School, with Supplementary Chapters on House Heating, Specifications and Surface Estimating.

BY

THOMAS E. McNEILL.

140 pages. Numerous illustrations and diagrams. 5x7 inches.
Cloth, \$1.00.

This handbook gives in a compact and practical form a series of questions and answers, with important supplementary chapters, covering the subject of steam and hot-water heating in a simple way. The need for a text-book of this kind has been much felt, and it is believed that this handy manual meets the requirement so fully that it will be appreciated by all who wish to master the principles, or acquire information in these important systems of heating.

Beginning with first principles, it progresses in a thorough manner, explaining the various systems of steam and hot-water heating, as well as the appliances and apparatus used, and the manner of connecting them.

CONTENTS.

Chap. 1. Tools, Fittings and Pipe.	Chap. 10. High and Low Pressure
“ 2. General Questions on Heating.	Steam Heating and Power Plant.
“ 3. Low Pressure Steam.	“ 11. Exhaust Steam Heating.
“ 4. Two Pipe Steam Heating.	“ 12. Power Fan or Blower System of Heating and Ventilating.
“ 5. Single Pipe Low Pressure Steam Heating.	“ 13. Design, Estimate, Specification.
“ 6. Indirect Steam Heating.	“ 14. Dwelling House Heating.
“ 7. Hot-Water Heating.	“ 15. A Successful Heating Job.
“ 8. Single Pipe Main System.	
“ 9. High Pressure Steam Heating.	

David Williams Company, Publishers,
232-238 William Street, New York.

PRACTICAL HINTS ON JOINT WIPING,

FOR BEGINNERS IN PLUMBING.

SIXTH EDITION, ENLARGED.

With an Appendix, Giving a Selection of Practical Letters and Articles compiled from *The Metal Worker*.

66 Pages. 41 Illustrations. Paper, 25 Cents.

This edition contains, besides the two original articles on joint wiping, by experts, a selection of letters and articles on various important phases of the subject.

These include the following :

Joint Wiping on Copper Pipe.	What Caused the Joint to Break ?
Wipe Joints on Brass and Iron.	Strength of Joints in Lead Pipe.
Wiping Joints on Tin Pipe.	Good Wiping Solder.
Wipe Joint on Lead and Iron Pipe.	Durability of Coarse Solder.
To Make Tight Joints.	Plumbers' Paste.
Froze the Pipe to Wipe a Joint.	Cleaning Solder.
Wiping Joints Without a Furnace.	What Breaks Wiped Joints ?
The Effect of a Jar on a Hot Wiped Joint.	Hard Solder to Resist Ammonia.

The first article in the book is written by a practical plumber, and is illustrated from photographs representing the hands and tools when wiping joints in various positions. The second, by an expert joint wiper, is also illustrated from photographs, and will prove of great assistance to learners. Ample instructions are given on preparing the pipes previous to wiping the joints, with full descriptions of all tools and appliances used. The pamphlet, in short, gives all the assistance that a description of the work can furnish, and is the most practical and complete account of joint wiping that is published.

25 CENTS, POSTPAID.

DAVID WILLIAMS COMPANY,
232-238 William Street, New York.

WE DEAL IN BOOKS

RELATING TO

All Branches of Mechanics

AND PUBLISH

THE METAL WORKER

A PRACTICAL JOURNAL

For Tanners, Roofers, Cornice Workers, Plumbers and the
Heating Trades

SUBSCRIPTION IN UNITED STATES AND BRITISH AMERICA,	A YEAR \$1.00
OTHER COUNTRIES,	3.00

DAVID WILLIAMS COMPANY
232-238 William Street
NEW YORK

H 62 90



HECKMAN
BINDERY INC.



JAN 90



N. MANCHESTER,
INDIANA 46962

LIBRARY OF CONGRESS



0 014 757 474 5

